

Chinmayagranthapushpam 9

# Tarkasaṅgraha of Annambhaṭṭa

English Translation with Notes

V N Jha



Chinmaya International Foundation Shodha Sansthan  
Adi Sankara Nilayam, Veliyanad  
Ernakulam, Kerala



# Tarkasaṅgraha of Annambhaṭṭa

English Translation with Notes

With best regards

W. Nijbo

9/05/2013

Journal of Annals

with Notes

Notes on the  
History of  
the  
State

*Chinmayagranthapushpam 9*

# Tarkasaᅅgraha of Annambhaᅇa

English Translation with Notes

by

V N Jha



Chinmaya International Foundation Shodha Sansthan

Adi Sankara Nilayam, Veliyanad

Ernakulam, Kerala

*Chinmayagranthapushpam 9*

ISBN 978-93-80864-03-7

Published with the financial assistance of Rashtriya Sanskrit Sansthan,  
Ministry of Human Resource Development, Govt. of India, New Delhi

Publisher: Director

Chinmaya International Foundation Shodha Sansthan

(Recognised by Rashtriya Sanskrit Sansthan and Mahatma Gandhi  
University)

Adi Sankara Nilayam, Veliyanad,

Ernakulam District - 682 319, Kerala, India

Tel/Fax: 91-484-2747104

E-mail: director@chinfo.org

Website: www.chinfo.org

© Chinmaya International Foundation Shodha Sansthan

First Edition 2010 January, 500 copies

Co-ordinator: V. Sheeba Sudheer, Deputy Director

Associates: N.D. Sarala Kumari, C.P. Ambika

Price: INR 200

---

Typeset: M.R. Radhika

Printed at Sreelakshmi Graphics, Perumbavoor

# Contents

<i>Benediction</i>	vii
<i>Preface</i>	ix
<i>Acknowledgment</i>	xi
Introduction	xiii
Text with Translation and Notes	1
Key Terms	122
Bibliography	130
Commentaries of <i>Tarkasaṅgraha</i>	139

Contents

Introduction

Part I. The History of the  
Ministry of Education

Part II. The Development of  
Education in the Colony

Part III. The Education of  
the Native Races

Part IV. The Education of  
the Chinese

Part V. The Education of  
the Malays

Part VI. The Education of  
the Europeans

Part VII. The Education of  
the Indians

Part VIII. The Education of  
the Sikhs

Part IX. The Education of  
the Jains

Part X. The Education of  
the Buddhists

Part XI. The Education of  
the Muslims

Part XII. The Education of  
the Christians



## Benediction

Tarkasaṅgraha is the most popular and the basic text of the Nyāya-vaiśeṣika school dealing with logic and epistemology. The popularity of the text rests on the fact that it presents all the salient concepts of the school in a cogent and lucid fashion. But hidden within its outer simplicity is an inner depth that has been unravelled by a host of commentaries written during the last four centuries. The study of this text will not only help in the understanding of the Nyāya-Vaiśeṣika school but will also lay a strong foundation for the comprehension of the principles of all other schools of Indian Philosophy. Once one captures the methods of cognitive analysis as presented in this system, one can handle any knowledge discipline with ease. Hence the famous statement of the Indian tradition: *kāṇāda pāṇinīya ca sarvaśāstropakāarakam*—logic and grammar are foundational for all systems of knowledge.

Though some English translations of this text are certainly available, there has been a long felt need to bring out a student-friendly book that caters to the needs of the present day students. The diagrammatic presentations of concepts and lucid explanatory notes on difficult aspects of the text will amply facilitate in understanding the concepts of Indian logic and epistemology with ease. I have no hesitation in asserting that this work of Prof. V. N. Jha is pre-eminently suited to all students of any discipline to begin their quest of Indian logic and epistemology.

It is indeed his sheer commitment to the Indian knowledge tradition that is responsible for this labour of love. As a student of Prof. V. N. Jha, I feel honoured to write this benedictory note for this unique work of his.

I pray to the Lord and Pūjya Gurudev Swami Chinmayanandaji that this translation and commentary of *Tarkasaṅgraha* reaches a large number of students and may all be benefited by its study.

In Srī Gurusmṛti,  
Swami Advayananda,  
President, CIF

## Preface

I feel immense pleasure in placing in the hands of our readers Prof. V. N. Jha's lucid English translation of *Tarkasaṅgraha* of Annambhaṭṭa with elaborate notes. Although this is a basic text of Nyāya-Vaiśeṣika system of Indian philosophy, it serves as a fundamental treatise to enter into the frame-works of other systems of Indian philosophy too with great ease. That is why; this text is compulsorily taught to all students of all disciplines of knowledge in our traditional educational system. Our world of experience carries names and forms. Here is an attempt in this text to capture the entire world of names and forms through language and that is why, this has become a fundamental text to enter into any intellectual discipline. It is a manual for the beginners. It deals with ontology, logic and epistemology. Although very brief in form, it is presented with profound clarity.

Annambhaṭṭa composed *Tarkasaṅgraha* and also a commentary on it called *Dīpikā* in the later half of the 17th Century. He was a Tailanga Brahmin of North Arcot (Chittoor) district of Andhra Pradesh who had settled down in Benaras. He is also the author of *Nyāya-pariśiṣṭa-prakāśa*.

Although there are several English translations of *Tarkasaṅgraha* still one will find that this translation of Prof. V. N. Jha is unique in the sense that it is lucid and simple and is augmented by elaborate explanatory notes with diagrams wherever necessary. His graphic

presentation of the abstract ideas will immensely help the readers concretize the concepts. An index of Key Terms of Nyāya with their English equivalents and a list of commentaries on *Tarkasaṅgraha* composed by various traditional scholars are also appended in this volume. Similarly, a detailed Bibliography of various editions of *Tarkasaṅgraha* along with its 93 commentaries and sub-commentaries have also been appended at the end of the text which will prove to be of great use to the advanced researchers.

The Chinmaya International Foundation Shodha Sansthan feels great joy in bringing out this publication because it will provide a great help to scholars of Indian philosophy in general and Nyāya-Vaiśeṣika philosophy in particular. We are thankful to Prof. Jha for allowing us to publish such a valuable and useful work by the Chinmaya International Foundation Shodha Sansthan. I also thank my colleagues for carrying out all works related to the publication of this volume. We are thankful to Rashtriya Sanskrit Sansthan, New Delhi for the financial assistance to bring out the book. I pray to Guruji and the almighty God for blessings.

Dilip Kumar Rana  
Director, CIFSS

## Acknowledgment

I taught this text of *Tarkasaṅgraha* in the Chinmaya International Foundation (CIF) in June, 2009. Swami Advayananda, the honourable Acharya of Sankara-nilaya, got my lectures video-recorded and made them available in 22 DVDs for the use of the learners of Indian logic and epistemology. He also requested me to prepare one English Translation of this text with elaborate notes for the learners. The present volume is an outcome of his advice.

Swami Advayanandaji's love for knowledge is indeed admirable. He is compassionate and therefore, is always engaged in preservation and dissemination of ancient Indian wisdom to the generations to come. I express my heartfelt gratitude to him. But for his constant reminder, this volume would not have seen its completion.

Dr. Dilip Kumar Rana, the Director of the Chinmaya International Foundation Shodha Sansthan (CIFSS) came forward to bring out this book on priority basis. He also prepared a detailed Bibliography of various editions of *Tarkasaṅgraha* which has been appended at the end of this volume. It has enhanced usefulness of this volume. I profusely thank him for this.

Dr. Sheeba Sudheer, the Deputy Director of CIFSS, has done the entire DTP work upto corrections of the final press copy with the help of her colleagues Smt. Sarala and Smt. Ambika. I want to put on record the excellent job done by this team devotedly. Dr. Sheeba may not like my thanking her and so I say: May God bless her!

Smt. Sarala and Smt. Ambika deserve special words of appreciation for adding value to this volume by appending a list of "Key Terms" along with their English equivalents of the Nyāya-Vaiśeṣika system of Indian philosophy and a list of commentaries on *Tarkasaṅgraha* composed by various traditional scholars. I wish both of them happiness and peace. I also take this opportunity to thank Professor Muraleemadhavan, the dynamic Chairman of the Shodha Sansthan, for encouraging the publication of śāstric texts.

I must mention here that the kind tolerance of my frequent absence from home by my wife, Prof. Ujjwala Jha (the Director of the Centre of Advanced Study in Sanskrit, University of Pune) and my daughter, Miss Vedashree Jha (a student of Engineering Science), has contributed immensely towards the completion of this work. May God grant them all that they want !

I have tried my best to make this English translation and Notes as lucid as possible using contemporary idiom and illustrative diagrammes. If it serves the purpose for which it is written I shall consider my efforts amply rewarded. Readers' suggestions will definitely be considered and incorporated in the next edition of this volume.

*āparitoṣād viduṣām na sādhu manye prayogavijñānam!*

( Kālidāsa's *Abhijñānaśākuntalam* )

V N Jha, Pune

## Introduction

There are six orthodox systems namely, Sāṅkhya, Yoga, Nyāya, Vaiśeṣika, Pūrvamīmāṃsā and Uttaramīmāṃsā. Pūrvamīmāṃsā is referred to as simply Mīmāṃsā and Uttaramīmāṃsā is popularly known as Vedānta. These six systems are called orthodox because they believe in the authoritative-ness of the Vedas.

As against these, there are three philosophical systems which do not believe in the authoritativeness of the Vedas. They are Cārvāka, Buddhist and Jaina systems. These are referred to as heterodox systems of Indian Philosophy.

The orthodox systems are also called āstika-darśana and heterodox systems are known as nāstika-darśana. Here the terms āstika and nāstika mean that system of thought which believes in the authoritativeness of the Vedas and that system of thought which does not believe in the authoritativeness of the Vedas respectively.

The terms āstika and nāstika do not mean here 'one who believes in God' and 'one who does not believe in God' respectively, because the system of Mīmāṃsā is an āstika-darśana and yet it does not believe in God. Similarly, there is nirīśvara-sāṅkhya and seśvara-sāṅkhya (yoga), Vaiśeṣika too did not have God in its sūtra-period.

All the six Vedic-philosophical systems were initially formulated in the sūtra-style. Kapilamuni composed *Sāṅkhya-sūtras*; Patañjali wrote *Yoga-sūtras*; Kaṇāda wrote *Vaiśeṣika-sūtras*; Gautama wrote *Nyāya-sūtras*, Jaimini composed *Mīmāṃsā-sūtras* and Bādarāyaṇa

composed *Vedānta-sūtras*. The thoughts of these systems developed through a very rich tradition of writing commentaries and sub-commentaries thereon which have recorded the intense dialogues between the heterodox systems on one hand and interorthodox systems on the other. These dialogues have added depth to Indian Philosophical systems.

Īśvarakṛṣṇa wrote *Sāṅkhyakārikā*; Vyāsa composed *Bhāṣya* on the *Yogasūtras*; Praśastapāda wrote *Bhāṣya* on the *Vaiśeṣikasūtras*; Vātsyāyana composed *Bhāṣya* on the *Nyāyasūtras*; Śabara wrote *Bhāṣya* on the *Jaimini-sūtras*; and the *Bādarāyaṇasūtras* were commented upon by various schools of Vedānta. Śaṅkarācārya wrote *Bhāṣya* on the *Vedāntasūtras*; likewise Nimbārka, Rāmānuja, Mādhva, and Vallabha composed elaborate commentaries from a specific point of view giving rise to various schools of Vedānta.

Therefore, Vedānta too is of various types: Advaita of Śaṅkara, Śivādvaita of Kashmira, Śuddhādvaita of Vallabha, Bhedābheda of Nimbārka, Viśiṣṭādvaita of Rāmānuja, Dvaita of Mādhva and Acintyabhedābheda of Caitanyamahāprabhu. Although popularly one understands by the term Advaita as Śaṅkara's Advaita, the philosophy of Bhartṛhari is called Śabdādvaita, that of Vallabhācārya as Śuddhādvaita and that of Kashmir Śaivism as Śivādvaita since their fundamental presuppositions are different. It is interesting to note that all these advaita-philosophers quote the same Vedic



text in support of their respective stand-points and this became possible only because their basic presuppositions were different.

Like-wise two different interpretations of the *Śābara-bhāṣya* gave rise to two schools of Pūrvamīmāṃsā: (1) Kumārila and (2) Prābhākara. Murāri created a third school of Pūrvamīmāṃsā by commenting directly on the *Mīmāṃsāsūtras* of Jaimini.

Indian philosophical systems acquired structural depth because they honored freedom in thinking and respected others' positions at intellectual levels. That is why we find that whenever a particular system takes up an issue for discussion it presents first of all what others have to say on that issue. Even Cārvāka's view is not ignored. It is a different matter whether others' views are to be accepted or rejected, but this could not be done without critical examination.

The Vaiśeṣika and the Nyāya systems were distinct in the beginning. God did not find a place in the Vaiśeṣika School and abhāva as an entity was not discussed in the Nyāya School. But gradually there was give and take between these systems and by the 10<sup>th</sup> Century A.D. we find that these two systems have merged into one system due to their similar world-views. Thereafter these systems have been referred to by a combined name Nyāya-Vaiśeṣika.

It appears that there has been intense debate between the Naiyāyikas and the Buddhist logicians and

philosophers for at least one thousand years, if not more, over a number of philosophical issues. Whether there is something called substance or not, where qualities are located; whether there is a whole independent of its parts or not, whether there is self or not, whether absence should be given a status of an entity or not, whether there is necessity of accepting philosophical God or not many such issues engaged the attention of these philosophers. This dialogical literature of one thousand years is called Prācīna-nyāya. It consists of the *Nyāyasūtras* of Gautama, *Nyāya-sūtra-bhāṣya* of Vātsyāyana, *Nyāyasūtra-bhāṣya-vārttika* of Udyotakara, *Nyāyasūtrabhāṣyavārttikatātparyāṭikā* of Vācaspatimiśra and *Nyāyasūtrabhāṣyavārttikatātparyāṭikāpariśuddhi* of Udayanācārya (10<sup>th</sup> Century A.D.).

This bulk of literature is an outcome of an issue-oriented dialogue and hence Prācīna-Nyāya may be characterized as prameya-pradhāna.

The 10<sup>th</sup> Century A.D. seems to be the turning point in the development of Nyāya-Vaiśeṣika thought. There is a shift of emphasis from prameya to pramāṇa (epistemology). This turning point gave birth to what is known as Navya Nyāya. From this period onwards we find that the Nyāya-Vaiśeṣika philosophers are engaged in preparing a precise language of discourse. They discovered that during the Prācīna-Nyāya period many a time the communication remained ambiguous because the language of discourse was ordinary Sanskrit language and hence they

decided to develop Navya Nyāya language which can be used for ambiguity-free communication in any field.

Once this language was developed by the 13<sup>th</sup> Century A.D., all thinkers and philosophers adopted this very Navya Nyāya language to analyze a thought and wrote books in their respective fields of discourse. This language became so popular that not only the Nyāya-Vaiśeṣika Philosophers but even the thinkers of Mīmāṃsā, Vedānta, Vyākaraṇa, Alaṅkāraśāstra and Dharma-śāstra wrote books in this language and even today the same language is adopted as a tool to analyze ordinary language and represent human thoughts by many traditional scholars.

The magnum opus of this period is the *Tattvacintāmaṇi* of Gaṅgeśopādhyāya of Mithila of the 12<sup>th</sup> or 13<sup>th</sup> Century A.D. In the year 1976, the *Nyāyasiddhāntadīpa* of Śāśadhara has come to light. This is argued to be prior to Gaṅgeśa by Bimal Krishna Matilal who critically edited the text and it was published from the L.D. Institute of Indology, Ahmedabad.

When *Tattvacintāmaṇi* reached Navadvīpa (today's Nadia District of West Bengal), it occupied a central place in the intellectual academic program of that place. Raghunātha Śīromaṇi wrote an epoch-making commentary called the *Dīdhiti* on it. Two great logicians of Bengal wrote two independent and critical commentaries on *Dīdhiti* which gave birth to practically two independent schools of Navya-Nyāya. They are Jagadīśa Tarkālaṅkāra and Gadādhara Bhaṭṭācārya of Navadvīpa, the place where

Caitanya Mahāprabhu started his Bhakti movement. The two schools of Navya Nyāya are popularly known as the Jagadīśa-school and the Gadādhara-school and the two commentaries on the *Dīdhiti* of Raghunātha are known as Jāgadiśī and *Gādādhari*.

As I have already mentioned, the worldview of the Nyāya-Vaiśeṣika system of philosophy and logic accepted the saptapadārthī model of capturing the entire world of human experience through natural language.

This was necessary because the Buddhist idealists as well as the Śāṅkarādvaitins held the view that reality could not be captured by language. The Nyāya-Vaiśeṣika philosophers challenged this position and wanted to demonstrate that nothing can be known unless the world is presented before us with a name and a form. This system did not accept degrees of reality as proposed by Śāṅkarācārya namely, vyāvahārika, prātibhāsika and pāramārthika levels of reality. If x exists, it is real and ultimately real. An atom (paramāṇu) is as much real as God and a sky-flower is as much fictitious as rabbits horn (śāśa-śṛṅga).

Language presents the world with a form and a name and there is no logic to prove that whatever is presented through language is false because that claim will also have to be made only through language.

The *Tarkasaṅgraha* of Annambhaṭṭa (1623 A.D.) is a very small but very profound treatise to introduce this world-view of the Nyāya-Vaiśeṣika system of philosophy

with utter clarity. It is a unique hand-book of Indian Logic and Epistemology. The method through which the entire universe has been analyzed through natural language is comparable to any analytic method of sciences and social sciences today. Training in this methodology empowers a serious enquirer to go deeper into any analysis of human mind. It is this reason that this text occupied a unique position in the traditional curriculum of any discipline of knowledge.

The traditional structure of presenting a scientific system consists of three things: (i) *uddeśa* (listing of items to be discussed), (ii) *lakṣaṇa* (defining each item of the list) and (iii) *parīkṣā* (critically examining whether the definitions apply properly to the items defined or not)

The *Nyāyadarśana* of Gautama is composed in this format. Annambhaṭṭa seems to have followed this format excepting the third component namely, *parīkṣā*.

The entire text of *Tarkasaṅgraha* follows the *uddeśa-lakṣaṇa*-model. This text presents clearly ontology, logic and epistemology of the system of Nyāya-Vaiśeṣika.

*Tarkasaṅgraha* can serve as the best text to develop the skill of Navya-Nyāya language too. At times we do find Annambhaṭṭa himself employing the Navya-Nyāya technique of defining a concept.

In the present day context, it has the capacity to serve as a basic introductory book to understand and analyze any thought of any academic discipline. The following sketch will show how the entire universe is captured and

analyzed through language and how beautifully the topics are arranged for discussion:

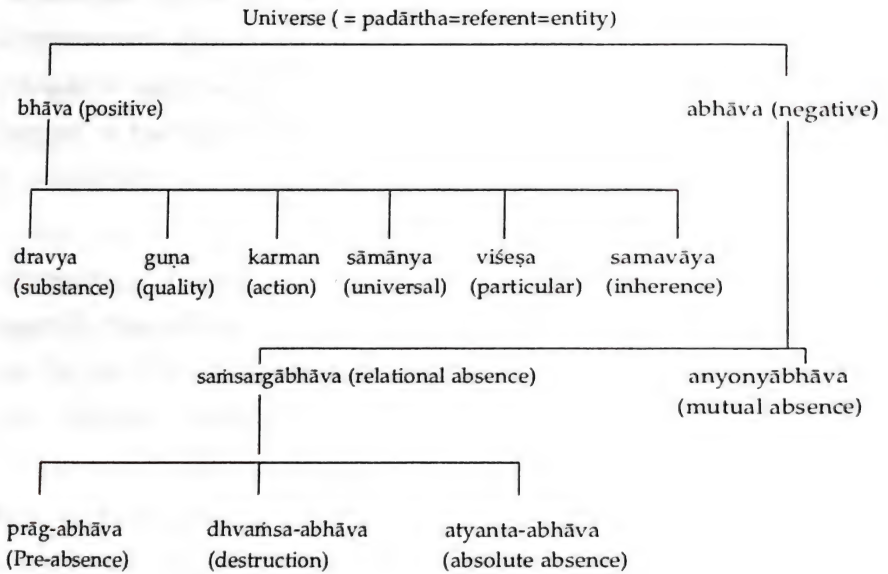

This is our entire universe and it has been captured in linguistic categorical terms. One thing one should note here. The whole universe has been categorized in two sets, one set of positive entities (bhāva-padārtha) and another set of negative entities or absence (abhāva-padārtha). This implies that in this world there are bhāva-referents as well as abhāva-referents. Thus, there is a particular rose-flower, for instance, in the garden and there is absence of that rose-flower too in this world. The absence is as much real as the rose. Both the bhāva-padārthas as well as the abhāva-padārthas are equally real and hence existent and vastu (entity). Abhāva is not tuccha or a-vastu or fictitious.

As a matter of fact since there are bhāva-padārthas which are real, there are abhāva-padārthas which have to be real. There cannot be absence of a fictitious entity. If some one talks about it, it does not make any sense in terms of reality.

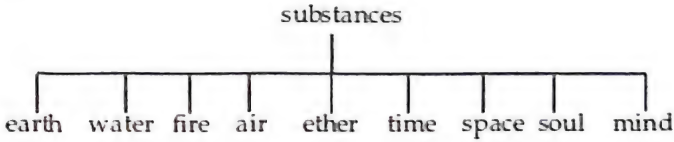

We are on the ground now. We deal with these nine substances. Of these nine the first seven are external and the last two are internal. Each individual is a soul delimited by body. Each soul is provided with a mind. Through this mind the individual soul gets connected with the internal as well as external world.

A substance is conceived as a locus where quality or action is produced. The list of 24 qualities is as follows:

rūpa (colour)	gurutva (gravity)
rasa (taste)	sneha (moisture)
gandha (smell)	śabda (sound)
sparśa (touch)	buddhi (cognition)
saṅkhyā (number)	sukha (happiness)
parimāṇa (extension)	duḥkha (unhappiness)
prthaktva (separateness)	icchā (desire)
saṁyoga (conjunction)	dveṣa (aversion)
vibhāga (disjunction)	prayatna (volition)
paratva (remoteness)	dharma (merit)
aparatva (nearness)	adharmā (demerit)
dravatva (liquidity )	saṁskāra (impression)

In this way, the remaining sub-sets have been presented and discussed. The classification of the entities has been so exhaustive that nothing is left out. In this very order each item is defined and discussed.

### ***English Translation:***

While translating this text into English I have tried to avoid the method of word-by-word translation, rather I have given more attention to making the issue, under discussion, clear. Communicational rather than philological approach has been respected. Modern idiom is preferred over traditional.

### ***Explanatory Notes:***

As an aid to this goal, after translation of each text explanatory notes have been added and wherever necessary and wherever possible, diagrams have been added into to make the abstract ideas, a bit concrete.

### ***How to Read a Diagram?***

A box represents a cognition or knowledge. For example, ghaṭa should be read as 'cognition or knowledge of ghaṭa (pot)'. It shows that ghaṭa appears as a content (viṣaya) of the cognition or knowledge. Relationships are shown by lines with some modifications.

Straight line A (—) B indicates relation in general.

An arrow (→) at the end of a line indicates the direction of relationship.



Thus  $A \rightarrow B$  means 'A' is related to 'B' and  $A \leftarrow B$  means 'B' is related to A.

A vertical line represents the relationship of 'locus-and-located' (*ādhāra-ādheya-bhāva*). Thus,

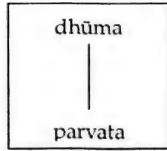

says that *dhūma* 'smoke' is located on *parvata* 'mountain'.

A hazy line '~~~~~' means there is a doubt about the relationship. Thus,

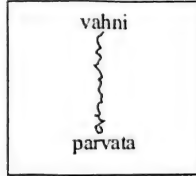

means 'there is a doubt about the contact of fire on the mountain.

A pair of parallel lines with an arrow at the end represents a delimiting relationship. Thus,

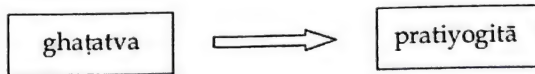

says that *pratiyogitā* is delimited by *ghaṭatva*.

A pair of parallel lines with arrows on both the ends represents the 'describer-and-described relationship' (nirūpya-nirūpaka-bhāva). Thus,

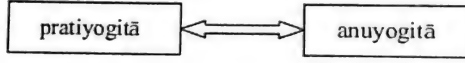

should be read as pratiyogitā-nirūpita-anuyogitā or anuyogitā-nirūpita-pratiyogitā.

A cause-and-effect relationship is represented by an arrow in which the tip of the arrow is connected with the effect and the beginning part is connected with cause. Thus,

daṇḍa → ghaṭa means daṇḍa 'stick' produces ghaṭa 'pot'.

A blank box indicates it is a cognition without any content (viṣaya). Thus,



means, it is a container or cognition which can have some content. It is nirākāra.

### ***Text: 1***

निधाय हृदि विश्वेशं विधाय गुरुवन्दनम्।  
बालानां सुखबोधाय क्रियते तर्कसङ्ग्रहः॥

*nidhāya hr̥di viśveśam vidhāya guruvandanam,  
bālānām sukhabodhāya kriyate tarkasaṅgrahaḥ.*

### ***Translation: 1***

*Having placed the lord of the universe in the heart (i.e. having remembered God) (and) having performed the prayer of the teacher (i.e. having prayed respectfully the teacher) the text called Tarkasaṅgraha (lit. the text which summarizes the logical system of Nyāya and Vaiśeṣika) is being composed (by me) for easy understanding of the learners.*

### ***Notes: 1***

There are six systems of Indian philosophy under the group called āstika-darśana (the philosophical system which accepts the authority of the Vedic lore) and there are three systems of Indian philosophy under the group called nāstikadarśana (the philosophical system which does not accept the authority of the Vedic texts). The six āstikadarśana-s are Sāṅkhya, Yoga, Nyāya, Vaiśeṣika, Pūrvamīmāṃsā and Uttaramīmāṃsā and the three nāstika darśana-s are Cārvāka, Bauddha and Jaina.

The Nyāya and Vaiśeṣika systems were distinct in the beginning. Gautama or Akṣapāda wrote *Nyāya-sūtra* to present the logic and philosophical doctrine of the Nyāya system and Kaṇāda wrote *Vaiśeṣika-sūtra* to present the world-view of the Vaiśeṣika system. But both the systems started developing similar world-views and as a consequence, by the 9<sup>th</sup>/10<sup>th</sup> Century A.D., both merged together to form a single system of logic, epistemology and philosophy of life called Nyāya-Vaiśeṣika system of Indian Philosophy. The *Tarkasaṅgraha* of Annambhaṭṭa is a systematic summary of that Nyāya-Vaiśeṣika system of Indian Philosophy.

The Nyāya-Vaiśeṣika system accepted God who created the universe of our experience. Hence, as an āstika he remembers God and his teacher under whom he studied this system of thought. He performs, as it were, an act of expressing gratitude to seek their blessings for successfully composing and completing the text. He does this in order to set an example for his disciples who will also express gratitude to the Creator and the Preceptor before taking up the task of composing a text. The following of this practice of the tradition will make the next generation humble.

### ***Text: 2***

द्रव्यगुणकर्मसामान्यविशेषसमवायाभावाः सप्त पदार्थाः ॥

*dravya-guṇa-karma-sāmānya-viśeṣa-samavāya-abhāvāḥ*  
*sapta padārthāḥ.*

***Translation: 2***

*Substance, quality, action, universal, particular (distinguishing feature), inherence (samavāya) and absence are the seven sets of referents (entities).*

***Notes: 2***

The significant contribution of the system of Nyāya-Vaiśeṣika is the analysis of the entire world of our experience in terms of language. It is everybody's experience that the world with which we behave, whole of our life appears, before us with a form (rūpa) and a name (nāman). We think in language and understand in language. Thus, the whole world can be conceived as a set of what language refers to, that is, referents or padārthaḥ (padasya arthaḥ). In other words, the entire universe of our experience is nothing but a sum total of referents of elements of a language which we speak and understand. We capture the universe through language and communicate it through language. This world is knowable and nameable. It is real and ultimately real. It is not the case that language cannot capture Reality. On the contrary, if x cannot be captured by language then there is no method available to human beings by which they can know the existence or reality of x. In this sense, language maps reality and the entire universe can be categorized in terms of language. A sentence is a verbalised cognition of the world. Therefore, when we are analysing language, infact, we are analysing thought and through that we are

analysing the thought-content i.e. the world. This is what the Nyāya-Vaiśeṣika system did.

It can be presented as follows:

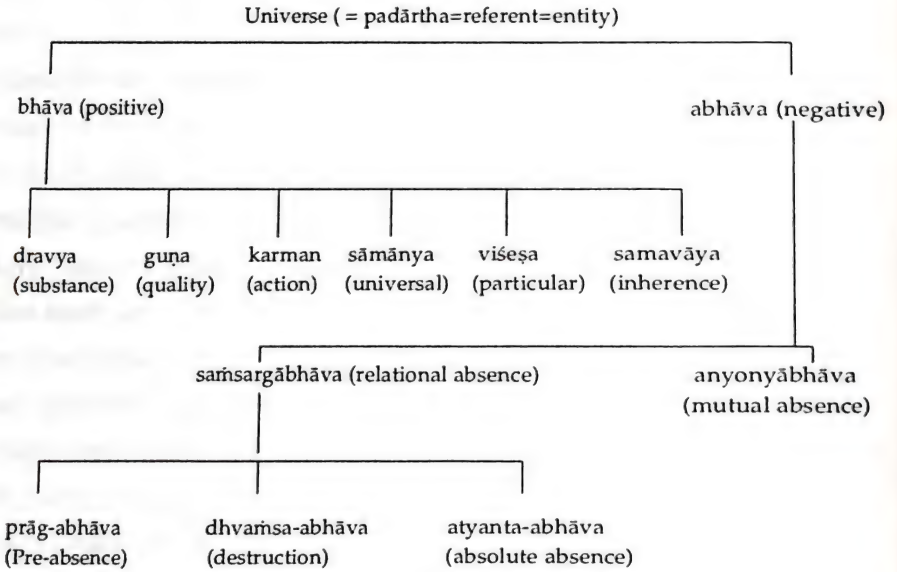

This is our entire universe and it has been captured in linguistic categorical terms. One thing one should note here. The whole universe has been categorized in two sets, one set of positive entities (bhāva-padārtha) and another set of negative entities or absence (abhāva-padārtha). This implies that in this world there are bhāva-referents as well as abhāva-referents. Thus, there is a particular rose-flower, for instance, in the garden and there is absence of that rose-flower too in this world. The absence of rose is as much real as the rose. Both the bhāva-padārthas as well as the abhāva-padārthas are equally real and hence existent and

vastu (entity). Abhāva is not tuccha or a-vastu or fictitious. As a matter of fact since there are bhāva-padārthas which are real, there are abhāva-padārthas which have to be real. There cannot be absence of a fictitious entity. If some one talks about it, it does not make any sense in terms of reality.

**Text: 3**

तत्र द्रव्याणि पृथिव्यप्तेजोवाय्वाकाशकालदिगात्ममनांसि नवैव॥

*tatra dravyāṇi pṛthivyaptejovāyvākāśakāladigātmmamanāṁsi navaiva.*

**Translation: 3**

*Of these, the substances are of nine types only such as earth, water, fire, air, ether, time, space, soul and mind.*

**Notes: 3**

We saw how the whole universe has been categorized in seven sets. Now one by one each set is being expanded by enumerating the members of each set. The first set is the set of substances. The substances are of nine types only. To put it diagrammatically:

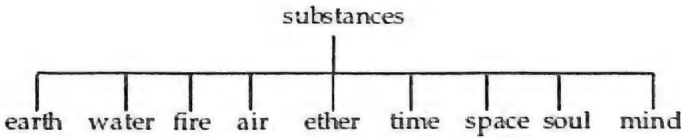

We are on the ground now. We deal with these nine substances. Of these nine the first seven are external and

the last two are internal. Each individual is a soul delimited by body. Each soul is provided with a mind. Through this mind the individual soul gets connected with the internal as well as external world.

A substance is conceived as a locus where quality or action is produced. The list of qualities is given in the next text.

**Text: 4**

रूपरसगन्धस्पर्शसङ्ख्यापरिमाणपृथक्त्वसंयोगविभागपरत्वापरत्वगुरुत्वद्रव-  
त्वस्नेहशब्दबुद्धिसुखदुःखेच्छाद्वेषप्रयत्नधर्मधर्मसंस्काराश्चतुर्विंशतिगुणाः ॥  
*rūpa-rasa-gandha-sparśa-saṅkhyā-parimāṇa-pṛthaktva-saṁ-  
yoga-vibhāga-paratvāparatva-gurutva-dravatva-sneha-śabda-  
buddhi-sukha-duḥkha-icchā-dveṣa-prayatna-dharmādharmā-  
saṁskārāścaturviṁśatiguṇāḥ.*

**Translation: 4**

Colour, taste, smell, touch, number, size, separateness, contact, disjunction, remoteness, nearness, heaviness (weight), fluidity, moisture, sound, cognition, pleasure, pain, desire, aversion, volition (mental readiness or preparedness), merit, demerit, and impression are the twenty-four qualities (of the substances).

**Notes: 4**

These twenty-four qualities reside in the substance only. No quality resides in another quality or in any other entity naturally. Qualities reside in their loci naturally by inherence (samavāya). In this list the first fifteen belong to



the external world and the remaining nine belong to the internal world.

Thus cognitions, pleasure, pain, desire, aversion, volition, merit, demerit and impression are the elements of our internal world. These occur in us (that is, in the soul which is a substance). These nine qualities are found only in the soul and hence they are treated as special qualities of the soul. For every individual these qualities occurring in his or her soul are exclusively internal and the rest of the world including these qualities in others' selves is external for him.

Thus, each individual is interacting with two worlds: internal and external in getting access to both the worlds.

***Text: 5***

उत्क्षेपणापक्षेपणाकुञ्चनप्रसारणगमनानि पञ्च कर्माणि॥

*utkṣepaṇāpakṣepaṇākucñcanaprasāraṇagamanāni pañca karmāṇi.*

***Translation: 5***

*Throwing up, throwing down, contracting, expanding and moving are the five types of actions.*

***Notes: 5***

As a matter of fact all these five types of action can be covered by a single term namely, 'movement'. Thus, these varieties are varieties of 'movement' only. A movement causes disjunction from one space and establishes conjunction with another space.

Like a quality, an action also resides in a substance. No action will have another action or any other entity as its natural locus. That is, no action resides in any entity other than substance by the relation of inherence.

Substance which has a limited size alone will have action. An omnipresent entity like soul, time, space, etc. cannot have movement.

***Text: 6***

परमपरञ्चेति द्विविधं सामान्यम्॥

*paramaparañceti dvividham sāmānyam.*

***Translation: 6***

*Pervader and pervaded are the two types of universal or generic property or class-forming property.*

***Notes: 6***

Universals are such properties which bring members to form one class. For instance, potness will bring individual pots to form a class of pots. A Universal, therefore, includes all members and excludes all those which are not the members of that class. Thus, it is a class-forming property.

It is of two types, keeping in view its extension. 'Potness' includes all pots, but 'earthness' includes all pots and also all those things which are made of earth. Thus, 'earthness' pervades 'potness' and 'potness' is pervaded by 'earthness'. Again, 'substanceness' will be pervader and 'earthness' will be pervaded by 'substanceness'. The

‘pervader’ occupies larger area in comparison to the ‘pervaded’.

**Text: 7**

नित्यद्रव्यवृत्तयो विशेषास्त्वनन्ता एव॥

*nityadravyavṛttayo viśeṣāstvanantā eva.*

**Translation: 7**

*However, the viśeṣa-s (i.e. the ultimate distinguishing factors of permanent substances) occurring in all permanent substances are innumerable.*

**Notes: 7**

It is to be remembered that the Nyāya-Vaiśeṣika system of philosophy believes in plural world. In pluralism each entity is considered to be unique and distinct. Two entities of even the same class have to be different. How to account for this difference? Two pots are different. Why? Because the parts of one are different from the parts of the other. Again, why two parts of the same whole are different? We will have to say that parts of one part are different from the parts of the other part. In this way one can go on asking the same question, and we will get the similar answer. Can we ever stop asking such question and getting the same reply? The result is the contingency of the fault of anavasthā. In order to come out of it one has to say that the two particles (paramāṇu) out of which the immediate whole was created are partless. Still the enquiry continues and one would like to know: Why two particles are different

from each other? It is here the Vaiśeṣika system introduced the idea of viśeṣa. They held the view that all particles, in other words, eternal substances must be provided with an ultimate distinguishing factor called viśeṣa on the ground of which two particles could be distinguished. Once the two particles are made distinct, two pots can be explained as distinct, without any problem. In the same way all other eternal substances like ether, time, space, souls and minds could be kept distinction on the basis of viśeṣa. This is how the reality of plurality is explained in this system. It is to be noted that it is because of accepting this unique entity called viśeṣa, the system is known as Vaiśeṣika system.

***Text: 8***

समवायस्त्वेक एव॥

*samavāyastveka eva.*

***Translation: 8***

*(The permanent relationship called) inherence is only one.*

***Notes: 8***

Although the entities in the world are distinct, they occur in a cluster in a situation. Thus, language presents them as related. Language is preceded by a qualified cognition (viśiṣṭa-jñāna). In a qualified cognition three elements appear: qualifier (viśeṣaṇa or prakāra), qualified (viśeṣya) and a relationship between the two.

This relationship can be either a product (hence anitya) or permanent (nitya). The relationship which is a product

is called samyoga or conjunction and it is included in the list of qualities. The permanent relationship is mentioned here as 'inherence'.

In this relation the two relata cannot be shown as existing independently. In the case of conjunction, however, the relata can exist independently. That is why, the conjunction is accepted as caused or produced and therefore, many; whereas inherence is not caused, therefore, permanent and hence only 'one'. There are five cases where we need to accept inherence:

(1) Between quality and a substance

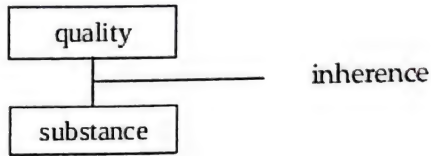

(2) Between action and a substance

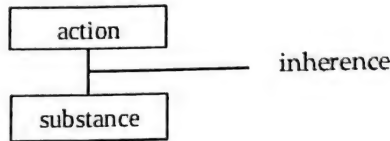

(3) Between universal and a particular (vyakti)

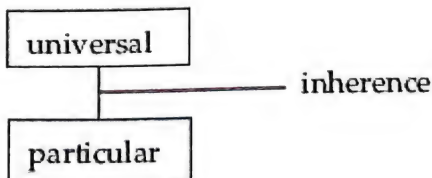

(4) Between a whole and its parts



(5) Between *viśeṣa*-padārtha (ultimate distinguishing factor) and the permanent substance

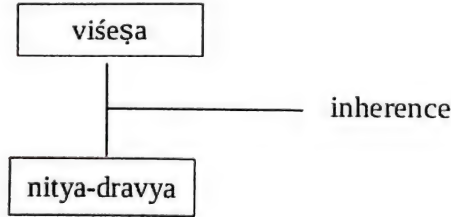

Although the cases are five there is only one permanent relationship called inherence. Only the relata are changing, not the relationship. Hence, inherence is only one.

**Text: 9**

अभावश्चतुर्विधः। प्रागभावः प्रध्वंसाभावोऽत्यन्ताभावोऽन्योन्याभावश्चेति।  
*abhāvaścaturvidhaḥ. prāgabhāvaḥ pradhvaṁsābhāvo'tyanta-*  
*ntābhāvo'nyonyābhāvaśceti.*

**Translation: 9**

Absence is of four types: pre-absence, destruction, absolute absence and mutual absence.

**Notes: 9**

We have already noted that an absence is as much real or existent as a positive entity is real and existent.

Before a positive entity is produced there has to be a pre-absence of that entity in its parts and after that positive entity is produced in its parts that pre-absence is destroyed. This is the first variety of absence called 'pre-absence'.

Again, when the positive entity is destroyed there emerges an absence of that positive entity in its broken state. That absence is called 'destruction' and when we are referring to an absence which is existent in all the three times: present, past and future, that absence is called absolute absence. This absence is the third variety of absence, for example, 'there is no pot on the ground'. Although it is difficult to grasp as an absence existing in all the three times – present, past and future – a little closer analysis may not leave any scope for such difficulty.

In this universe, every entity exists somewhere by some relationship. That is why we can say that by that relation that entity does not exist in some other place. A pot can exist in some other place. A pot can exist on a specific ground by the relation of 'contact' and when it does not exist by contact on another ground we refer to that absence as absolute absence. Here in fact, what we are negating is the relationship (i.e. contact) by which the pot rested.

This absence not only exists today, it existed yesterday and will exist tomorrow too. It exists not only here, but

exists in the entire universe. This implies that such an absolute absence exists even on the ground where there is pot. Then, the question may arise, if the absence of pot exists also in the locus of pot, why can we not say 'there is no pot on the ground? The answer to this question is 'because the counter-positive of that absence i.e. the pot is present there' and knowledge of absence cannot arise if the counter-positive (pratiyogin i.e. virodhin i.e. abhāva-jñāna-virodhin) is present in the locus of its absence. Thus, the absolute absence is nitya and is present everywhere.

The fourth variety of absence is the mutual absence. In the world each entity is distinct. It means that each entity is identical with itself and different from everything other than itself. In other words, each entity is related to itself by the relation of identity and to the rest of this world by the relationship of difference. Every entity possesses difference from the rest of the entities of the world. This difference is nothing but the mutual absence. Thus, while an absolute absence is denial of the relation of difference, the mutual absence is the denial of the relationship of identity.

### ***Text: 10***

गन्धवती पृथिवी। सा द्विविधा नित्यानित्या चेति। नित्या परमाणुरूपा। अनित्या कार्यरूपा। पुनस्त्रिविधा। शरीरेन्द्रियविषयभेदात्। शरीरमस्मदादीनाम्। इन्द्रियं गन्धग्राहकं घ्राणं नासाग्रवर्ति। विषयो मृत्पाषाणादिः।

*gandhavatī pṛthivī. sā dvividhā nityānityā ceti. nityā paramāṇurūpā. anityā kāryarūpā. punastrividhā. śarīrendri-*



*yaviṣayabhedāt. śarīramasmadādīnām. indriyaṃ gandha-  
grāhakaṃ ghrāṇam nāsāgravartī. viṣayo mṛtpāṣāṇādīḥ.*

**Translation: 10**

Of these (substances) the earth can be defined as 'that which has smell'.

This earth is of two types: (1) eternal and (2) non-eternal. Eternal forms of earth are the earth-particles and non-eternal forms of the earth are all the products (made of earth). Again, the earth in the form of product that is in the gross form can be divided into three types: (1) body (of living beings), (2) sense-organs and (3) gross objects (made of earth). For example, bodies like ours, the sense-organs that reveals the smell. That is situated (in a minute form) at the tip of the nose. The objects (made of earth) are the gross form of earth, stone etc.

**Notes: 10**

From text number two upto text number nine there is a broad classification and enumeration of entities which constitute the whole world. From Text no. 10 onwards, each entity from the list of enumerated padārthas' being defined and discussed.

In the list of substances, the first entity is the earth and it is conceived as the locus of smell.

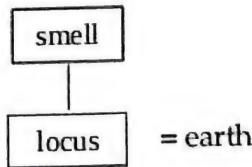

What is the idea of a definition after all?

Definition is nothing but a property (dharma) by which we characterize the thing to be defined (lakṣya). That property should be an uncommon or peculiar property in the sense that it will include all members of that class of entities and will exclude all that do not belong to that class. How to achieve it?

The neologicians (Navya-Naiyāyika) therefore, offered a definition of a definition: *asādhāraṇa-dharmaḥ lakṣaṇam. asādhāraṇatvaṁ ca lakṣyatāvacchedakasamanīyatatvam.*

‘An uncommon or peculiar property is called the defining property (lakṣaṇa) of an entity to be defined (lakṣya).

The uncommonality or peculiarity (asādhāraṇatva) of such property stands for ‘the state of being pervade and at the same time being the pervader of the property which delimits the property of being the thing to be defined (lakṣyatā).’

*samanīyatatvañca lakṣyatāvacchedaka-vyāpyatve sati lakṣyatāvacchedaka-vyāpakatvam.*

‘Being co-extensive means being pervaded by and being pervader of the delimitor (avacchedaka) of the property of being the thing to be defined (lakṣyatā).’

Let us try to understand this with the help of an example. Suppose, we want to define ‘cow’ (go). The moment we decide to define a cow, the cow becomes ‘the thing to be defined because a new property (āgantuka-dharma) comes to reside in cow called lakṣyatā. This new

property can come to reside anywhere in anything which we want to define. But we are not defining now 'anything' but 'cow' only. So how to say this or specify this?

The Navya-Naiyāyikas developed a language to specify this. They developed a concept called avacchedaka or delimitor. An avacchedaka is a specifier of the locus of the āgantuka-dharma, the new property or the acquired property or the contextual property. When we are going to define 'cow', the new property called lakṣyatā is produced in the cow:

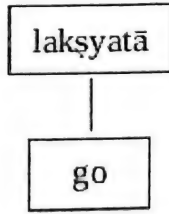

Now to say or specify that this lakṣyatā is in 'go' (cow) alone and not in any other entity at this moment we should delimit this new property namely, lakṣyatā by some property present in 'cow' which is lakṣya.

But there are many properties in 'go'. 'Go' is a padārtha and hence it has padārthatva; it is a dravya and it has dravyatva; it is made of earth and so it has pṛthivītvā and it is called a cow and so it has gotva. So how to select a property? Which of these four properties can serve as a delimitor of lakṣyatā in cow?

If we select padārthatva, it will mean we are defining any padārtha; but it is not true since we are defining

only go. Thus, padārthatva cannot be the delimiter of the lakṣyatā of go. Then, can dravyatva serve the same purpose? Obviously not, because we are not defining any dravya but only 'go'. Similarly, pṛthivītva also cannot be delimiter of lakṣyatā of 'go' because pṛthivītva exists in all entities made of pṛthivī and we are not defining any thing made of earth but only cow.

Gotva, however, can serve such purpose because it exists only in go and nowhere else. Therefore, gotva alone can specify the locus of lakṣyatā. That is why, gotva will be selected as the delimiter of lakṣyatā of 'go'. It can be put as follows:

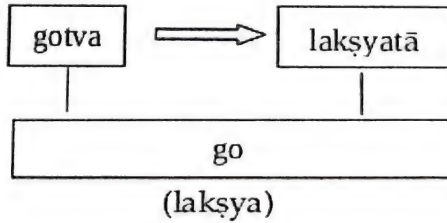

This means that we are talking of the definition of 'cow':

An avacchedaka, therefore, has to be co-extensive (anyūna-anatirikta-vṛtti) with the avacchinna. It should occupy the same area which is occupied by the avacchinna, not less not more.

Here, the āgantuka-dharma namely, lakṣyatā is avacchinna and gotva is avacchedaka. When we are defining 'cow', lakṣyatā is in all cows and only in cows and the cowness (gotva) exists in all cows and only in cows.

Therefore, gotva alone which is a svābhāvika-dharma or natural property or inherent property (samaveta-dharma) can be the delimiter of lakṣyatā, the āgantuka-dharma of the cows which is free from the defects namely over-application (ativyāpti), narrow-application (a-vyāpti) and non-application (asambhava).

An avacchedaka should be free from these defects too. Gotva is free from these three defects and hence it can be the delimiter of lakṣyatā.

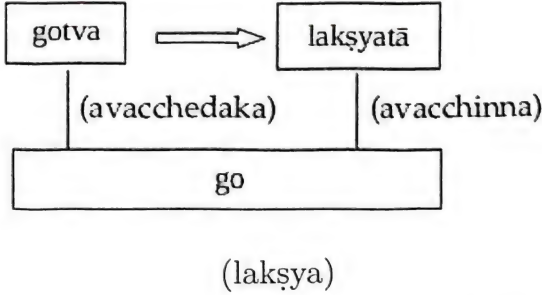

Now, we know clearly that we are going to define a 'cow'.

The next issue is which peculiar property of cow can be identified as the definition of cow, since there are several features in cow.

The method by which such a property is to be identified is to verify whether a property selected as 'the definition' is co-extensive with the delimiter of the lakṣyatā or not. If it is co-extensive, it should be selected as a definition without any problem.

The test of co-extensiveness (samaniyatatva) is to see that 'wherever there is the defining feature (asādhāraṇa-dharma), there is the delimiter of the lakṣyatā and

wherever there is the delimiter of the lakṣyatā, there is the defining feature'. If this is true, one can select that feature (asādhāraṇa-dharma) as the definition of the thing to be defined.

In our example, gala-kambala or sāsnā (dewlap) can be that defining feature because it satisfies the above-mentioned test. Wherever there is dewlap there is 'cowness' and wherever there is cowness there is dewlap. Thus, 'dewlap' is co-extensive (samaniyata) with 'cowness' and hence dewlap can be treated as the definition of a cow.

If anybody defines a cow as 'that which possesses horns' this definition will apply to not only cows but to any other animal also which has horns, which is not desirable. Here, arises a defect called ativyāpti (over-application) which is defined as:

*lakṣya-alakṣya-vṛttitvam ativyāptih.*

'The defect of a definition called 'over-application' is that where the definition applies in that which is to be defined (lakṣya) and also in that which is not intended to be defined (a-lakṣya)'.

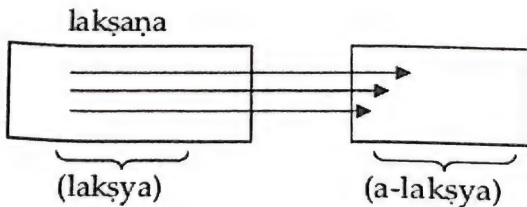

A definition should be free from this defect.

Again, if some one defines a cow as 'that animal which possesses white colour' it will apply only to white cows and not to cows having other colour'. Thus, this definition suffers from the defect of *avyāpti* (narrow-application), which is defined as:

*lakṣyaikadeśa-avṛttitvam avyāptiḥ*

'That which is not present in all that is intended to be defined' i.e. not present in a part of it.' It can be put as follows:

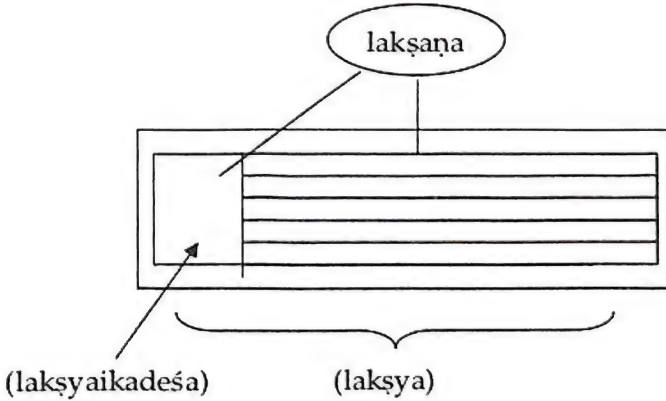

A proper definition must avoid this defect.

Similarly, if some one defines a cow as 'that animal which has cloven hooves,' it will not apply to any cow because it suffers from the defect called *asambhava* which is defined as:

*lakṣyamātra-avṛttitvam asambhavaḥ.*

'Non-application is that defect of a definition where the definition does not apply to any case which is intended to be defined.'

To put it diagrammatically:

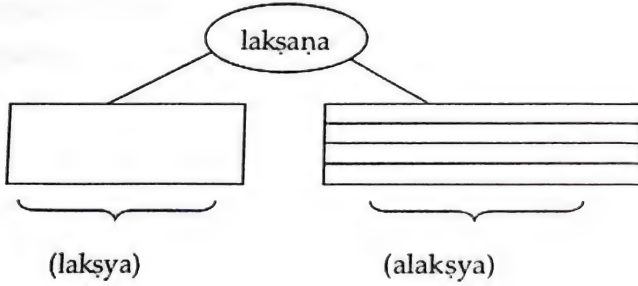

This defect should also be avoided. Therefore, it is said that only that peculiar property can be a perfect definition which is free from all these three types of defects.

*doṣa-traya-rahitaḥ asādhāraṇa-dharmo lakṣaṇam.*

Gandha 'smell is such a property in terms of which 'earth' can be defined. The earth possesses the following qualities: colour, taste, smell, touch, number, size, discreteness, conjunction, disjunction, remoteness, nearness, weight and fluidity. Smell is called the special quality of the earth. That is why earth could be defined in terms of smell. Ordinarity, a quality in the paramāṇu is taken as permanent. But rūpa, rasa, gandha and sparśa of the atoms of the earth cannot be treated as permanent because they can change by heating.

### **Text: 11**

शीतस्पर्शवत्य आपः। ता द्विविधाः नित्या अनित्याश्च। नित्याः परमाणु-  
रूपाः। अनित्याः कार्यरूपाः। पुनस्त्रिविधाः शरीरेन्द्रियविषयभेदात्। शरीरं  
वरुणलोके। इन्द्रियं रसग्राहकं रसनं जिह्वाग्रवर्ति। विषयः सरित्समुद्रादिः॥



*śītasparśavatya āpaḥ. tā dvividhāḥ. nityā anityāśca. nityāḥ paramāṇurūpāḥ. anityāḥ kāryarūpāḥ. punastrividhāḥ śārīrendriyaviṣayabhedāt. śārīraṃ varuṇaloke. Indriyaṃ rasa-grāhakaṃ rasanāṃ jihvāgravartī. viṣayaḥ saritsamudrādīḥ.*

**Translation: 11**

Water is that which possesses cold touch. It is of two types: Eternal and non-eternal. Eternal forms of water would be atoms of water and non-eternal forms of water would be effects or products or masses made out of those atoms. Again we classify water-bodies in three groups viz. bodies made of water, the sense organ made of water and objects made of water. The body made of water is to be found in the world of Varuṇa; the sense organ is the organ of taste which we all have and that is located at the tip of the tongue; the objects made of water are the water bodies like river, ocean etc.

**Notes: 11**

In Sanskrit the word āpaḥ is always used in plural. The stem (prātipadika) is ap 'water'.

Natural touch of water is cold and therefore, it has been defined in terms of that. When water is heated it can become hot, but hot touch is not its natural touch.

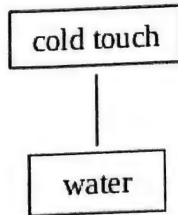

Water can have the following qualities: rūpa, rasa, sparśa, saṅkhyā, parimāṇa, pṛthaktva, saṃyoga, vibhāga, paratva, aparatva, gurutva, dravatva, sneha.

It is interesting to note that the Nyāya-Vaiśeṣika systems even respect mythological information. The Vedic and Purāṇic traditions mention varuṇa-loka, 'world of varuṇa', āditya-loka, 'world of sun' and vāyu-loka, 'world of vāyu' where bodies made of water, fire and air respectively can be found. The Indian logicians have given space for these mythological entities as well.

This clearly shows how comprehensive is the canvas of the Indian logicians who do not want to ignore cultural inputs of any source: literature, social belief, folklore, mythology. They have shown respect by offering a space for these items in their structure of ontological analysis. This is something unique.

### **Text: 12**

उष्णस्पर्शवत्तेजः। तद्विद्विधं नित्यमनित्यञ्चेति। नित्यं परमाणुरूपमनित्यं कार्यरूपम्। पुनस्त्रिविधं शरीरेन्द्रियविषयभेदात्। शरीरमादित्यलोके। इन्द्रियं रूपग्राहकं चक्षुः कृष्णताराग्रवर्ति। विषयश्चतुर्विधः। भौमदिव्यौ-दर्याकरजभेदात्। भौमं वह्न्यादिकम्। अबिन्धनं दिव्यं विद्युदादि। भुक्तस्य परिणामहेतुरौदर्यम्। आकरजं सुवर्णादि॥

*uṣṇasparśavattejaḥ. tadvividham nityamanityañceti. nityam paramānurūpamanityam kāryarūpam. punastriavidham śarīrendriyaviṣayabhedāt. śarīramādityaloke. indriyam rūpagrahakam cakṣuḥ kṛṣṇatārāgravarti. viṣayaścaturvidhaḥ bhaumadivyaudaryākarajabhedāt. bhaumam vahnnyādikam.*

*abindhanam divyam vidyudādi. bhuktasya pariṇāmaheturaudaryam. ākarajam suvarṇādi.*

**Translation: 12**

Fire or heat or light is that which possesses hot touch. It is of two kinds: eternal and non-eternal. The eternal form of light are the atoms of light and the non-eternal form of light are the mass made of those atoms. Again, we can classify light in three forms viz. body made out of light; the sense organ made of light and the objects made out of light. The body made of light can be seen in the region of the Sun; the sense organ made of light are our eyes which reveal colour and that is located at the tip of the pupil of the eyes. The objects made of light are of four types viz. ordinary fire, celestial light, and minerals. The fire of the first category is our ordinary fire, of the second category is the celestial lightening which is produced by water and of the third category the heat i.e. digestive fire in our stomach which causes the digestion of the food that we eat and the fourth category is the minerals such as gold etc.

**Notes: 12**

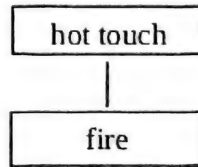

The minerals like 'gold' etc. are considered to be 'fire' on logical grounds. Since gold does not get evaporated by

the heat of fire, it cannot be included in earth and water and since it has colour it cannot be included in air, sky, time, space, soul and mind. Therefore, by the principle of elimination, it is included in the category of fire.

May be, at the time of Kaṇāda, the knowledge of Physics was of that level. We will have to understand the text in that light. These ancient texts are not the reports of any physical laboratory and hence one should not try to read modern science there.

But in any case, the logical method of enquiry needs to be appreciated.

Fire can have the following qualities: rūpa, sparśa, saṅkhyā, parimāṇa, pṛthaktva, saṃyoga, vibhāga, paratva, aparatva and sāmśiddhika-dravatva (fluidity caused by heat since gold is also treated as fire).

### **Text: 13**

रूपरहितस्पर्शवान् वायुः। स द्विविधो नित्योऽनित्यश्च। नित्यः परमाणु-  
रूपोऽनित्यः कार्यरूपः। पुनस्त्रिविधः। शरीरेन्द्रियविषयभेदात्। शरीरं  
वायुलोके। इन्द्रियं स्पर्शग्राहकं त्वक्सर्वशरीरवर्ति। विषयो वृक्षादिकम्पन-  
हेतुः। शरीरान्तःसञ्चारी वायुः प्राणः। स चैकोऽप्युपाधिभेदात्प्राणापानादि  
संज्ञा लभते॥

*rūparahitasparśavān vāyuh. sa dvividho nityo'nityaśca.  
nityaḥ paramāṇurūpo'nityaḥ kāryarūpaḥ. punastrividhaḥ.  
śarīrendriyaviṣayabhedāt. śarīraṃ vāyuloke. indriyaṃ  
sparśagrāhakaṃ tvaksarvaśarīravarti. viṣayo vṛkṣādika-  
mpanahetuḥ. śarīrāntaḥsancārī vāyuh prāṇaḥ. sa caiko'pi  
upādhibhedāt prāṇāpānādisaṃjñā labhate.*

**Translation: 13**

Air is that substance which possesses touch but does not possess colour. It is of two kinds: eternal and non-eternal. Eternal air is in the form of atoms of air and non-eternal in the form of effect or product. Again air can be classified into three types viz. body made of air, sense organ made of air, and objects made of air. The body made of air is to be found in the vāyu-loka, the sense organ made of air is our faculty of touch which reveals touch, it is present throughout our body. The object made of air can be identified in the cause of shaking of tree etc. and our breathing air which moves inside our body. Although air is one mass we call it by different names such as prāṇa (breathing air) apāna (the gas which passes through our anal) etc. due to the extraneous factors (upādhi).

**Notes: 13**

Air has the following qualities: sparśa, saṅkhyā, parimāṇa, pṛthaktva, saṁyoga, vibhāga, paratva, and aparatva.

The air which is moving inside the body is called prāṇa (breath). Although it is one, it is known by different names in terms of the regions through which it passes. The names are:

(i) prāṇa (ii) apāna (iii) samāna (iv) udāna (v) vyāna.

The commentary called *Nṛsiṁha-prakāśikā* on the *Tarkasaṅgrahadīpikā* explains it as follows: *hṛdi vṛttivāt mukhanāsikābhyām niṣkramaṇāt praveśanāt ca prāṇa ityucyate. gudasthānavṛttivāt malādīnām adhonayanāt*

*ca apānaśabdena vyavahriyate. nābhivṛttivāt bhuktasya pākārthaṁ vahneḥ samunnayanācca samāna ityucyate. karṇadeśasthitatvāt ūrdhvanayanācca udāna ityucyate.*

*sarvaśarīravṛttivāt sarvanāḍīṣu praveśanācca vyāna iti ucyate.*

Thus, breathing air is prāṇa; the wind passing through anus is apāna; the air that activates the digestive fire in the stomach is called samāna; the air near the region of ears is called udāna; and the wind which moves throughout the body including the veins (nāḍī) is called vyāna.

### **Text: 14**

शब्दगुणकमाकाशम्। तच्चैकं विभु नित्यञ्च।

*śabdaguṇakamākāśam. taccaikam vibhu nityam ca.*

### **Translation: 14**

*Sky or ether is that substance which is the material cause of sound i.e. one, all-pervading and eternal.*

### **Notes: 14**

Sound is produced in the sky and sky is the material cause (samavāyi-kāraṇa).

Sky is to be understood as vibhu which is defined as 'that which is connected with all substances having a limited size (mūrta-dravya). Sky is also said to be eternal. The concept of nitya is 'that which never becomes the counter-positive (pratiyogin) of destruction. In other words that which is never destroyed is called eternal.

**Text: 15**

अतीतादिव्यवहारहेतुः कालः। स चैको विभुर्नित्यश्च॥

*atītādivyavahārahetuḥ kālah. sa caiko vibhurnityaśca.*

**Translation: 15**

*Time is that substance which causes us to refer to past, present and future. That is one, all-pervading and eternal.*

**Notes: 15**

Everything comes into being in time. That is why, time is said to be the locus of everything. The whole universe is in time. This time is called mahākāla. Our reference to segments of time in ordinary language is the reference to khaṇḍa-kāla (assumed unit of time in terms of the sun-rise and sun-set). As a matter of fact, time is indivisible, eternal, one and vibhu like the sky.

**Text: 16**

प्राच्यादिव्यवहारहेतुर्दिक्। सा चैका विभ्वी नित्या च॥

*prācyādivyavahāraheturdik. sā caikā vibhvī nityā ca.*

**Translation: 16**

*Space is that substance which causes the reference to directions such as east, west, north, south etc. that space is one all-pervading and eternal.*

**Notes: 16**

Diś is direction or space. Language presents reference to it by referring to different directions such as east, west, north,

south etc. The *Nṛsimha-prakāśikā* commentary provides an easy way to identify the space. He says that when we refer to some entity in a language, it is done in terms of the delimiter of the property of being usable in language (vyavahartavyatā-avacchedaka).

Here the vyavahartavya is say, prāg-dig-vān 'possessing eastern direction' that is pratīcī 'east' and the property of being vyavahartavya that is vyavahartavyatā is in prāg-dig-vaṭ i.e. in something that exists in the east and there the delimiter of vyavahartavyatā is, therefore, prāgdik.

Thus, to refer to 'east' we need to have an entity called prācī. As we need ghaṭatva to refer to ghaṭa, so we need diś to refer to direction or space.

### **Text: 17**

ज्ञानाधिकरणमात्मा। स द्विविधो जीवात्मा परमात्मा च। तत्रेश्वरः सर्वज्ञः  
परमात्मा एक एव। जीवात्मा तु प्रतिशरीरं भिन्नो विभूर्नित्यश्च॥

*jñānādhikaraṇamātmā. sa dvividho jīvātmā paramātmā  
ca. tatreśvaraḥ sarvajñaḥ paramātmā eka eva. jīvātmā tu  
pratiśarīraṁ bhinno vibhurnityaśca.*

### **Translation: 17**

Soul or self (jīvātman) is that substance which is the locus of knowledge. The Self is of two categories: the living beings, and God. Out of these two, God is all-knowing and only one. Living beings on the other hand are many, distinct with each body, all-pervading and eternal.



**Notes: 17**

Ātman is soul or Self. Ātman is also God. Ātman is a substance no doubt, but it is not of the nature of either earth, or water, or fire, or sky, or time or space or mind. It is a spiritual substance. It is the locus of our inner world namely, cognition, knowledge, happiness, unhappiness, desire, aversion, volition, merit, demerit and impressions. Ātman is the material cause of these qualities. These qualities are produced only in the ātman. These are the members of our inner world. Ātman is not conscious by nature. But ātman alone is capable of becoming conscious. Conscious is one who has consciousness. Consciousness is the property of the conscious. Cetana is not consciousness. If ātman is said to be cetana, it can only be called locus of caitanya. Consciousness, therefore, is the property of the ātman which makes the ātman conscious. This consciousness, therefore, is the cognition or knowledge or desire or volition in terms of which the ātman is called cetana. Consciousness is the guṇa of the soul which is a substance. God, however, is always cetana because His knowledge, desire and volition are eternal. An individual Self is cetana only after jñāna or icchā or prayatna is produced in him. His knowledge or desire or volition is a product because it is acquired and hence non-eternal. Ātman alone is capable of becoming cetana. In jīvātman, jñāna is said to be āgantuka i.e. a kārya or a product.

The jīvātman acquires knowledge through the instrument of mind and an instrument cannot be equated

with the agent who uses it and therefore, ātman is not even 'mind'. Ātman is a distinct spiritual substance. God alone is always cetana, because He possesses eternal knowledge.

**Text: 18**

सुखदुःखाद्युपलब्धिसाधनमिन्द्रियं मनः। तच्च प्रत्यात्मनियतत्वादनन्तं  
परमाणुरूपं नित्यञ्च॥

*sukhaduḥkhādyupalabdhisāadhanamindriyaṃ manaḥ. tacca  
pratyātmaniyatatvādanantaṃ paramāṇurūpaṃ nityañca.*

**Translation: 18**

*Mind is the internal sense organ of our awareness of happiness, unhappiness, etc., and that mind is unique to each self and therefore, it is innumerable, it is of the size of an atom and it is eternal.*

**Notes: 18**

We have seen that a knower acquires knowledge of the world. In other words, he internalizes the world and makes the world an object of his knowledge. As he internalizes the external world so he internalizes the inner world. He requires an instrument to internalize. He internalizes the external world through the external senses. There are five external senses and the knower is an all-pervading substance and so the Self is related to all of them at a time and hence there is a possibility of internalizing the external world through all sense organs simultaneously. But it is against our experience. We do not have perception of colour, taste, smell, touch and sound simultaneously. To

explain this, it is necessary to say that at a time the Self is using only one sense organ to acquire perception of only one thing. This is achieved by introducing an entity called 'mind' in between the self and the external sense organ.

Thus, Self comes in contact with the mind, mind with the sense-organ, and the sense-organ with the external object and thus the perception of the external world, one at a time, becomes possible. Moreover, this is our every day experience that many a time we remain absent-minded and some one thinks that I am looking at him, but in fact I am not looking at him because I may be thinking something else and that leads to misunderstanding, and I am required to resolve the misunderstanding by telling him that 'I was absent-minded and really I did not see him.'

This fact also supports the presupposition that there is mind and it gets related to one sense organ at a time.

Moreover, as we have perception of the external world so also we have perception of our inner world. How do we know it? The proof is our verbalizations like 'I am happy' 'I am unhappy', 'I have knowledge', 'I have desire' etc. These sentences have verbalized our mental perceptions of our inner world, namely, happiness, unhappiness, knowledge, desire, etc.

Thus, as the self requires 'mind' to connect himself with external world through the senses, so also he requires 'mind' to acquire the knowledge of the inner world.

Therefore, each self must be provided with an instrument called 'mind' to internalize the external world

as well as the internal world. Thus, there are as many selves so many 'minds'. The size of the mind is accepted as the size of an atom because it moves fast. It plugs in with a particular sense-organ and the next moment it establishes its contact with another sense organ. This becomes feasible only when it is provided with minimum possible size. Since it has smallest possible size it can have maximum possible velocity (vega).

Thus, mind is a substance. It is different from the self. It is an instrument used by the Self. It has smallest possible size. It has highest possible speed. Mind is plural, each self is provided with a 'mind'. It is permanent.

**Text: 19**

चक्षुर्मात्रग्राह्यो गुणो रूपम्। तच्च शुक्लनीलपीतरक्तहरितकपिशचित्रभेदात्  
सप्तविधम्। पृथिवीजलतेजोवृत्तिः। तत्र पृथिव्यां सप्तविधम्। अभास्वर-  
शुक्लं जले। भास्वरशुक्लं तेजसि॥

*cakṣurmātragrāhyo guṇo rūpam. tacca śuklanīlapītarakta-  
haritakapiśacitrabhedāt saptavidham. pṛthivījalatejovṛtti.  
tatra pṛthivyāṁ saptavidham. abhāsvaraśuklaṁ jale.  
bhāsvaraśuklaṁ tejasi.*

**Translation: 19**

Colour is that quality which is revealed by eyes alone. Colour is of seven types white, blue, yellow, red, green, brown and mixed colour (citra). Colour is found in earth, water, and light. In the earth, all the seven can be found, in water non-radiant white, in light radiant white.

**Notes: 19**

Colour can be known only by eyes. That is why, a blind person cannot have a perception of colour, although he can have perception through other sense-organs like touch, ears, nose and tongue. Some qualities can be known by more than one sense-faculty, e.g. 'number'. It can be known by eyes and by 'touch'.

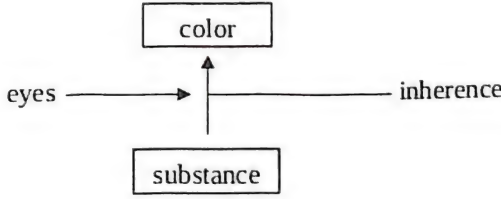

The faculty of eyes is made of light and hence it can reveal colour.

**Text: 20**

रसनग्राह्यो गुणो रसः। स च मधुराम्ललवणकटुकषायतिक्तभेदात् षड्विधः। पृथिवीजलवृत्तिः। पृथिव्यां षड्विधः। जले मधुर एव॥

*rasanagrāhyo guṇo rasaḥ. sa ca madhurāmlalavaṇakaṭukaśāyatiktābhedaāt ṣaḍvidhaḥ. pṛthivījalavṛttiḥ. pṛthivyām ṣaḍvidhaḥ. jale madhura eva.*

**Translation: 20**

Taste is that quality which is revealed by tongue. The taste is of six types: sweet, sour, salty, hot, astringent and bitter. These tastes are found in earth and water. In earth, all the six types but in water only sweet.

**Notes: 20**

Tongue alone can reveal 'taste'. Taste also, therefore, is ekendriya-grāhya-guṇa.

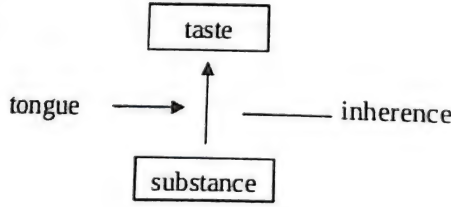

The faculty of 'tongue' is made of 'water' and hence it reveals taste.

**Text: 21**

घ्राणग्राह्यो गुणो गन्धः। स द्विविधः। सुरभिरसुरभिश्च पृथिवीमात्रवृत्तिः॥  
*ghrāṇagrāhyo guṇo gandhaḥ. sa dvividhaḥ. surabhirasura-*  
*bhiśca pṛthivīmātravṛttiḥ.*

**Translation: 21**

Smell or odor is that quality which is revealed by nose. That is of two types: fragrant and foul. It is found only in the earth.

**Notes: 21**

The faculty of 'nose' is made of earth and earth is the natural locus of smell. Therefore, through nose the external entity called 'smell' can be internalized. Smell is revealed by only one faculty such as 'nose'.

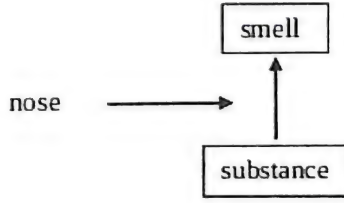

### **Text: 22**

त्वग्निन्द्रियमात्रग्राह्यो गुणः स्पर्शः। स त्रिविधः शीतोष्णानुष्णाशीतभेदात्। पृथिव्यप्तेजोवायुवृत्तिः। तत्र शीतो जले। उष्णस्तेजसि। अनुष्णाशीतः पृथिवीवाय्वोः। रूपादिचतुष्टयं पृथिव्यां पाकजमनित्यम्। अन्यत्रापाकजं नित्यमनित्यञ्च। नित्यगतं नित्यम्। अनित्यगतमनित्यम्॥

*tvagindriyamātragrāhyo guṇaḥ sparśaḥ. sa trividhaḥ śīto-  
ṣṇānuṣṇāsītābhedāt. pṛthivyaptejovāyuvṛttiḥ. tatra śīto  
jale. uṣṇastejasi. anuṣṇāsītaḥ pṛthivīvāyvoḥ. rūpādicatu-  
ṣṭayam pṛthivyām pākajamanityam. anyatrāpākajam nitya-  
manityañca. nityagataṁ nityam. anityagatamanityam.*

### **Translation: 22**

Touch is that quality which is revealed by the faculty of touch. That is of three types: cold, hot and warm. It is found in earth, water and air. Cold in water, hot in heat and warm in earth and air. colour, taste, smell and touch found in the earth are changeable or transformable by heating, elsewhere however, they are not transformable and hence either eternal or non-eternal. They are eternal when they are situated in eternal substances and they are non-eternal when they are situated in non-eternal substances.

**Notes: 22**

The faculty of 'touch' is made of air. Therefore, it can internalize 'touch'. Obviously, 'touch' can be known by faculty of touch only.

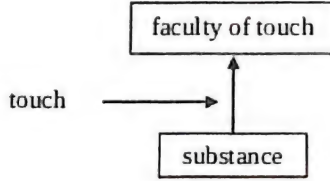

**Text: 23**

एकत्वादिव्यवहारहेतुः सङ्ख्या। नवद्रव्यवृत्तिरेकत्वादिपराद्धपर्यन्ता।  
 एकत्वं नित्यमनित्यञ्च। नित्यगतं नित्यमनित्यगतमनित्यम्। द्वित्वादिकन्तु  
 सर्वत्रानित्यमेव॥

*ekatvādivyavahārahetuḥ saṅkhyā. navadravyavṛttirekatvā-  
 diparārdhāparyantā. ekatvaṁ nityamanityaṅca. nitya-  
 gatam nityam. anityagatamanityam. dvitvādikantu sarva-  
 trānityameva.*

**Translation: 23**

Number is that quality in terms of which reference like 1,2,3...etc. is made. It exists in all these nine substances. The range of numbers, known in the tradition, is from 1 upto parārdha (i.e.  $10^{16}$ ). Number one is a basic number and it is eternal when it exists in eternal substance and it is non-eternal when it exists in non-eternal substance. All higher numbers starting from two are non-eternal.



**Notes: 23**

Each individual entity possesses 'number one'. If the locus of number 'one' is non-eternal like any product, it will be non-eternal; but if the locus is eternal such as time, space, self etc. it will be eternal. From number two onwards all higher numbers are constructed and hence non-eternal. Number can be revealed by eyes as well as by faculty of touch. This is a proof that number is the part of external reality.

**Text: 24**

मानव्यवहारकारणं परिमाणम्। नवद्रव्यवृत्ति। तच्चतुर्विधम्। अणु महद्दीर्घं  
ह्रस्वञ्चेति॥

*mānavyavahāraṅkāraṇam parimāṇam. navadravyavṛtti.  
taccaturvidham. aṇu mahaddīrgham hrasvañceti.*

**Translation: 24**

Measure is that quality which helps in referring to measurement. It exists in all the nine substances. It is of four types: minute, big, long and short.

**Notes: 24**

This is comparable to the idea of size or 'extension'.

There can be three types of size: minimum possible size; maximum possible size and middle size.

An atom is of the minimum possible size; a pot has middle size and time, space, self etc. are of maximum possible size.

**Text: 25**

पृथग्व्यवहारकारणं पृथक्त्वम्। सर्वद्रव्यवृत्तिः॥

*prthagvyavahāraṅgaṅaṃ prthaktvam. sarvadravyavṛttih.*

**Translation: 25**

*Discreteness is the uncommon cause of referring to all discrete entities. It exists in all substances.*

**Notes: 25**

In this world every entity is distinct and there is no mixture. When we can say the substance 'a' is distinct from 'b' it means each of them possesses a quality called 'distinctness'.

**Text: 26**

संयुक्तव्यवहारहेतुः संयोगः। सर्वद्रव्यवृत्तिः॥

*saṁyuktavyavahārahetuḥ saṁyogaḥ. sarvadravyavṛttih.*

**Translation: 26**

*Contact or conjunction is the cause of reference to the notion of connectedness. It exists in all substances.*

**Notes: 26**

A contact or conjunction can be between two substances only. This is a constructed relation and therefore, it is breakable.

The other two types of relation are inherence which is a permanent entity and a third category of relationship is called self-liking relationship.

**Text: 27**

संयोगनाशको गुणो विभागः। सर्वद्रव्यवृत्तिः।

*saṁyoganāśako guṇo vibhāgaḥ. sarvadravyavṛttiḥ.*

**Translation: 27**

*Disjunction is the quality that destroys conjunction. It exists in all substances.*

**Notes: 27**

Disjunction is preceded by conjunction.

As a matter of fact disjunction is brought about by destroying the conjunction. The idea of disjunction implies the idea of conjunction, but the idea of conjunction does not imply the idea of disjunction.

**Text: 28**

परापरव्यवहारासाधारणकारणे परत्वापरत्वे पृथिव्यादिचतुष्टयमनोवृत्तिनी।  
ते द्विविधे दिक्कृते कालकृते च। दूरस्थे दिक्कृतं परत्वं समीपस्थे  
दिक्कृतमपरत्वम्। ज्येष्ठे कालकृतं परत्वम्। कनिष्ठे कालकृतमपरत्वम्॥

*parāparavyavahārāsādhāraṇakāraṇe paratvāparatve. pṛthivīyādīcatuṣṭayamanovṛttinī. te dvividhe dikḥkṛte kālakṛte ca. dūrasthe dikḥkṛtaṁ paratvaṁ. samīpasthe dikḥkṛtaṁ aparatvam. jyeṣṭhe kālakṛtaṁ paratvam. kaniṣṭhe kālakṛtaṁ aparatvam.*

**Translation: 28**

*Remoteness and nearness are the uncommon cause of reference to things at a far distance and near distance.*

They are of two types: spatial and temporal. When something is at a far distance there is remoteness in it. That remoteness is a spatial remoteness. When something is at a closer distance there is nearness in it and this nearness is also caused by space. With reference to a person who is senior in age there is temporal remoteness in him and in a younger person there is temporal nearness.

**Notes: 28**

Temporal and spatial references are made on the basis of these qualities of remoteness and nearness.

**Text: 29**

आद्यपतनासमवायिकारणं गुरुत्वम्। पृथिवीजलवृत्ति॥  
*ādyapatanāsamavāyikāraṇaṁ gurutvam. pṛthivījalavṛtti.*

**Translation: 29**

Weight is the non-material cause of the first moment of falling of an object. It exists in Earth and Water.

**Notes: 29**

A solid object falls down because of weight (gravitation).

**Text: 30**

आद्यस्यन्दनासमवायिकारणं द्रवत्वम्। पृथिव्यप्तेजोवृत्ति। तद्विद्विधम्।  
सांसिद्धिकं नैमित्तिकञ्च। सांसिद्धिकं जले। नैमित्तिकं पृथिवीतेजसोः।  
पृथिव्यां घृतादावग्निसंयोगजं द्रवत्वम्। तेजसि सुवर्णादौ॥  
*ādyasyandanāsamavāyikāraṇaṁ dravatvam. pṛthivyaptejo-  
vṛtti. tadvividham. sāṁsiddhikaṁ naimittikañca. sāṁsi-*

*ddhikam jale. naimittikam pṛthivītejasoḥ. pṛthivyām ghr̥tā-dāvagnisamyogajam dravatvam. tejasi suvarṇādau.*

**Translation: 30**

*Fluidity is the non-material cause of the first moment of flowing of a liquid substance. It exists in earth, water and fire or light. That is of two kinds: natural and incidental. The natural fluidity is found in water and incidental or caused fluidity is found in earth and fire. The fluidity in the earth is caused by contact with fire as in the case of ghee etc. and the fluidity in fire is seen in mineral substance gold etc.*

**Notes: 30**

As because of 'weight' there is downward movement in the solid object, similarly, because of fluidity there is movement in a fluid substance.

**Text: 31**

*चूर्णादिपिण्डीभावहेतुर्गुणः स्नेहः। जलमात्रवृत्तिः॥*  
*cūrṇādipinḍībhāvaheturguṇaḥ snehaḥ. jalamātravṛttih.*

**Translation: 31**

*Moisture is the quality which helps the powder (of wheat etc.) coming into the form of a ball. It exists only in water.*

**Notes: 31**

That because of which moulding is possible is called moisture. This is the property of water.

**Text: 32**

श्रोत्रग्राह्यो गुणः शब्दः। आकाशमात्रवृत्तिः। स द्विविधो ध्वन्यात्मको  
वर्णात्मकश्च। ध्वन्यात्मको भेर्यादौ। वर्णात्मकः संस्कृतभाषादिरूपः॥

*śrotragrāhyo guṇaḥ śabdaḥ. ākāśamātravṛttiḥ. sa dvividho  
dhvanyātmako varṇātmakaśca. dhvanyātmako bheryādau.  
varṇātmakaḥ saṁskṛtabhāṣādirūpaḥ.*

**Translation: 32**

Sound is the quality which is revealed by our ears. It exists only in the ether. It is of two types: Noise and linguistic noise such as phones etc. Example for noise will be when one beats a drum etc. and the linguistic noise is any language like Sanskrit etc.

**Notes: 32**

Both, the linguistic and non-linguistic noise, are called śabda. Its medium is believed to be the sky (ether ?) as per the knowledge of physics of those days.

**Text: 33**

सर्वव्यवहारहेतुर्ज्ञानं बुद्धिः। सा द्विविधा। स्मृतिरनुभवश्चेति॥

*sarvavyavahāraheturjñānaṁ buddhiḥ. sā dvividhā. smṛti-  
ranubhavaśceti.*

**Translation: 33**

Knowledge is that cognition which prompts all behaviors of living beings. That is of two types: remembrance and experience.

**Notes: 33**

Human beings perform three types of behaviour (a) the act of going forward to get something (b) the act of withdrawal to get rid of something and (c) the conscious act of remaining neutral. All these three kinds of behavior are prompted by a cognition or knowledge.

The knowledge presents the world before the knower with a form and a name and if he wants it he goes to collect it; if he does not want it he withdraws from it and if he neither wants to get it nor to get rid of it he remains indifferent. But in any case it is the cognition or knowledge that prompts these behaviors.

It is our experience that some behaviors or activities are successful in the sense that whatever is shown by cognition, the same is obtained; while some other behaviors are not successful in the sense that there 'x' is shown by cognition, but 'y' is obtained. But in both the cases the prompting factor is nothing but cognition.

It is only after one gets the same thing which was shown by the cognition, one comes to conclude that the prompting cognition was a true cognition and when he meets a failure he comes to conclude that the prompting cognition of his behavior was a false cognition.

Thus, all behaviors are prompted by cognition.

**Text: 34**

संस्कारमात्रजन्यं ज्ञानं स्मृतिः। तद्विभ्रं ज्ञानमनुभवः। स द्विविधो यथार्थो  
अयथार्थश्चेति॥

*samskāramātrajanyaṃ jñānaṃ smṛtiḥ. tadbhinnam jñāna-  
manubhavaḥ. sa dvividho yathārtho ayathārthaśceti.*

**Translation: 34**

Remembrance is that cognition which is caused by impressions alone left behind by experiences. whatever is not remembrance is an experience. That is also of two types: true and false.

**Notes: 34**

Cognition is an experience. It comes and goes. But before vanishing it leaves behind some impressions which cause remembrance later. Thus, cognition other than remembrance is called experience which may be true or false. Similarly, remembrance produced by impressions which are left behind by a true experience is also true and a remembrance produced by impressions left behind by a false experience is false.

**Text: 35**

तद्वति तत्प्रकारकोऽनुभवो यथार्थः। सैव प्रमेति उच्यते। यथा रजते इदं  
रजतमिति ज्ञानम्॥

*tadvati tatprakārako'nubhavo yathārthaḥ. saiva prameti  
ucyate. yathā rajate idaṃ rajatamiti jñānam.*

**Translation: 35**

A true experience is that which reflects the qualifier in its own locus. This is called knowledge. For example the knowledge of 'this is silver' in silver.



**Notes: 35**

If there is a reality say, 'x' in this world and when I know it, if it appears as 'x', this cognition will be called a true cognition.

To explain: Every entity which is referred to by language in this world exists with the following structure:

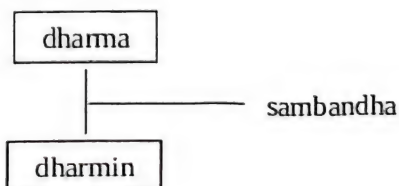

Thus, 'pot' exists as

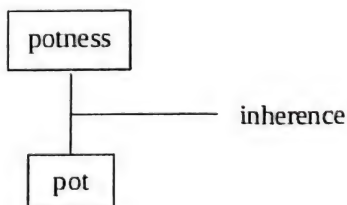

If it is the case that when this 'pot' is internalized by say, the process of perception, it goes inside the cognition and reflects the same structure such as

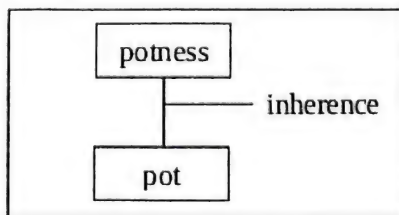

cognition of pot

We can say that this is a true cognition where 'potness' (x-ness) has appeared in its own locus (x).

The definition may be understood as follows:

Tat = x - ness

Tad-vat = x (= possessor of x-ness)

x- ness is the qualification of x and so in the cognition of x, if x-ness appears as the qualifier it is to be treated as a true cognition or experience.

For instance if 'silverness' appears in the knowledge of its own locus i.e. silver it will be called the true cognition of 'silver' where tat means 'silverness'

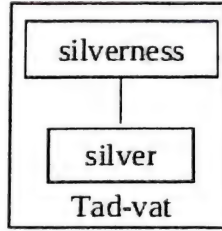

(This is silver)

### **Text: 36**

तदभाववति तत्प्रकारकोऽनुभवोऽयथार्थः। स एव भ्रम इत्युच्यते। यथा शुक्ताविदं रजतमिति ज्ञानम्॥

*tadabhāvavati tatprakāraḥko'nubhavo'yathārthaḥ. sa eva bhrama ityucyate. yathā śuktāvidaṁ rajatamiti jñānam.*

**Translation: 36**

*A false cognition is that experience which reflects qualifier in a locus which, in fact, possesses absence of that qualifier. This is called an error or erroneous cognition.*

**Notes: 36**

But if it is a case that 'silverness' appears in the cognition which emerges after looking at a conch-shell by mistake, this cognition of 'silver' will be called a false cognition because here 'silverness' has appeared in the locus where there is absence of 'silverness' since that locus (the conch-shell is not the natural locus of 'silverness').

To put it diagrammatically,

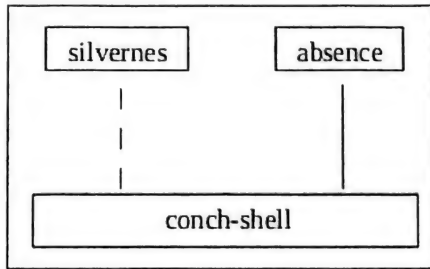

(This is silver (error) )

Where tat is 'silver-ness'

Observe that even an erroneous cognition can prompt human behavior.

In any case of behavior, the prompting cognition must be a verbalizable cognition because it is the verbalizable cognition or a savikalpaka-jñāna which presents the world clearly with a name and a form.

**Text: 37**

यथार्थानुभवश्चतुर्विधः। प्रत्यक्षानुमित्युपमितिशाब्दभेदात्। तत्करणमपि  
चतुर्विधम्। प्रत्यक्षानुमानोपमानशब्दभेदात्॥

*yathārthānubhavaścaturvidhaḥ pratyakṣānumityupamitiśā-  
bdabhedāt. tatkaṇamapi caturvidham. pratyakṣānumāno-  
pamānaśabdabhedāt.*

**Translation: 37**

A true cognition is of four types:

- (i) perceptual
- (ii) inferential
- (iii) analogical and
- (iv) verbal.

*The instrument that is, the process through which these four types of cognitions are produced is also of four types viz. pratyakṣa, anumāna, upamāna, and śabda.*

**Notes: 37**

There are four processes of internalizing the world. Internalizing means making the world an object of cognition. Each process generates a distinct type of cognition. Thus, the world can be an object of a perceptual cognition, or an inferential cognition or an analogical cognition or a verbal understanding. The Nyāya Vaiśeṣika system accepts only four types of cognition and corresponding to these four types, they accept only four processes of internalizing i.e. only four pramāṇas.

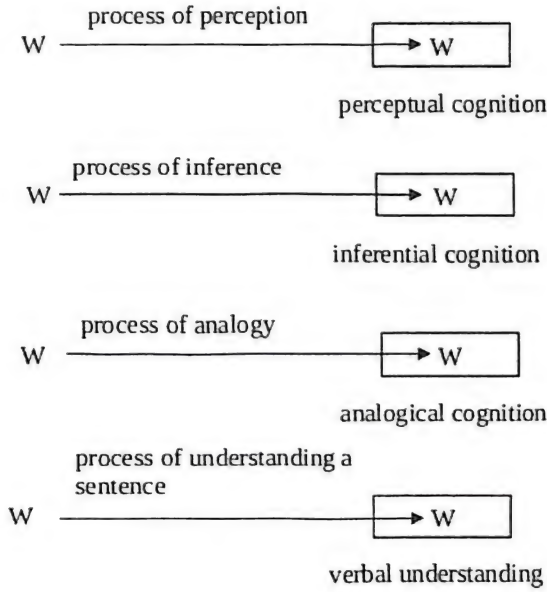

### Text: 38

असाधारणं कारणं करणम्। कार्यनियतपूर्ववृत्ति कारणम्। कार्यं प्रागभाव-  
प्रतियोगि। कारणं त्रिविधम्। समवाय्यसमवायिनिमित्तभेदात्। यत्समवेतं  
कार्यमुत्पद्यते तत्समवायिकारणं यथा तन्तवः पटस्य पटश्च स्वगत-  
रूपादेः। कार्येण कारणेन वा सहैकस्मिन्नर्थे समवेतत्वे सति यत्कारणं  
तदसमवायिकारणं यथा तन्तुसंयोगः पटस्य, तन्तुरूपं पटरूपस्य।  
तदुभयभिन्नं कारणं निमित्तकारणम्। यथा तुरीवेमादिकं पटस्य।  
तदेतत्त्रिविधकारणमध्ये यदसाधारणं कारणं तदेव करणम्॥

*asādhāraṇam kāraṇam karaṇam. kāryaniyatapūrvavṛtti  
kāraṇam. kāryam prāgabhāvapratiyogi. kāraṇam trivi-  
dham samavāyiasamavāyininimittabhedāt. yatsamavetaṁ  
kāryamutpadyate tatsamavāyikāraṇam. yathā tantavaḥ  
paṭasya paṭasāca svagatarūpādeḥ. kāryeṇa kāraṇena vā  
sahaikasmin arthe samavetatve sati yatkāraṇam tad*

*asamavāyikāraṇam. yathā tantusamyogaḥ paṭasya tantu-  
rūpaṁ paṭagatarūpasya ca. tadubhayabhinnam kāraṇam  
nimittakāraṇam. yathā turīvemādikaṁ paṭasya. tadetat  
trividhakāraṇamādhye yadasādhāraṇam kāraṇam tadeva  
karaṇam.*

**Translation: 38**

An instrument or process is that uncommon factor which is involved in a function. A cause is that which invariably precedes an effect. An effect is that which is the counter-positive of a pre-absence. Cause is of three kinds (i) material (ii) non-material and (iii) efficient.

The material cause is that where an effect is produced by the relationship of inherence. For example the threads are the material cause of cloth and cloth is the material cause of its colour.

The non-material cause is that which exists in a locus of either the effect or the cause. For e.g., the contact of the threads is the non-material cause of the cloth and the colour of the thread is the non-material cause of the colour of the cloth. An efficient cause is that which is different from both these varieties e.g. the instruments of the weavers are the efficient cause of cloth. Of these three types of cause whatever is uncommon is called an instrument.

**Notes: 38**

A cause is a factor or a kāraka which is involved in producing an effect. Pramāṇa or the process of

internalizing the world is an instrumental case (karaṇa-kāraka).

What is instrumentality? There are several notions of instrumentality. We may discuss here some of them. Let us take the following:

- (1) phalāyoga-vyavacchinnaṁ kāraṇaṁ karaṇam
- (2) vyāpāravadasādhāraṇaṁ kāraṇaṁ karaṇam
- (3) sāmāgrīkaraṇam

Let us say that x produces y through z. This can be presented as follows:

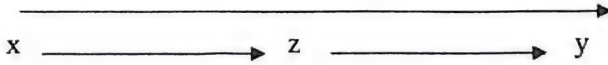

Here x is the function (vyāpāra) of x .

If z is a function it should satisfy the two following conditions:

it has to be produced by x and it will produce y which is produced by x.

The śāstric formulation of the concept of vyāpāra goes like this – *tajjanyatve sati tajjanyaajanakaḥ vyāpāraḥ*.

where tat means x and the first tat-janya stands for z and the second tajjanya stands for y.

Thus, the definition of vyāpāra will read like the following:

Vyāpāra is that which is produced by x and which produces y which is also produced by x.

Here, if we apply the first notion of karaṇa stated above (1) we will identify z as the instrumental case

because immediately after z, y comes into being. That is an instrument immediately after which the result comes into being. Thus, vyāpāra is an instrument according to this view.

If we apply the concept (2) mentioned above, x will become the instrument because it is x which is involved in the function of z. And if we apply the third concept (3) mentioned above the collection of all factors leading to y will be considered to be the karaṇa-kāraṇa.

What we find here in this text of *Tarkasaṅgraha* is the second concept of karaṇa is applied.

A cause is that which invariably precedes its effect and which is not redundant either.

A substance alone can be the material cause and quality and action only can be a non-material cause.

The following illustrations will make the concept clear.

Material cause

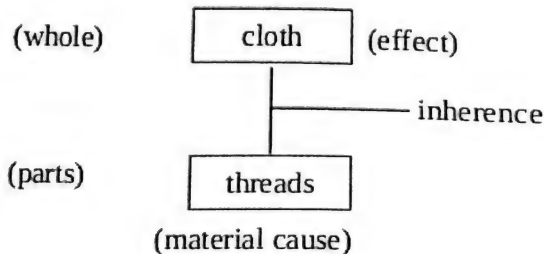

Here, the whole namely, the cloth is produced in the threads by the relation of inherence. Therefore, threads are the material cause of cloth.



Non-material cause

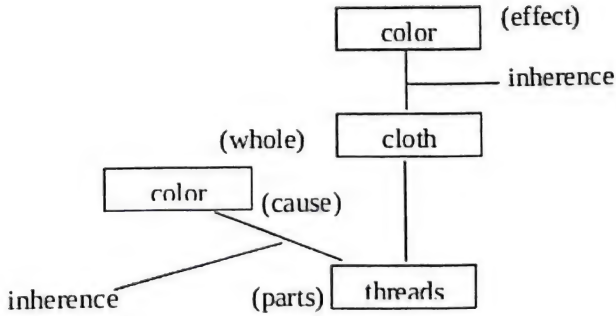

Here, the colour of the threads is the non-material cause of the effect namely, the colour of the cloth because the colour of the thread exists in the same locus by inherence where the material cause (i.e. the cloth) of the effect i.e. the colour of the cloth also exists. The material as well as the non-material cause of the colour of the cloth exist in one and the same locus namely, the threads.

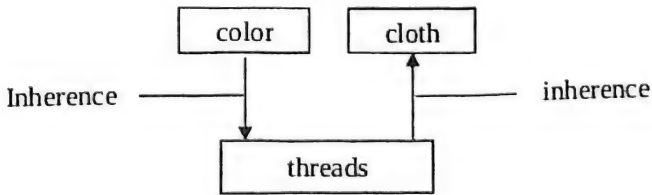

This is how the colour of the threads get related to the cloth.

All other factors needed to produce an effect are grouped in one box called auxiliary cause or efficient cause.

All effects are analyzed in this system in terms of these three types of causes, material, non-material and auxiliary.

**Text: 39**

तत्र प्रत्यक्षज्ञानकरणं प्रत्यक्षम्। इन्द्रियार्थसन्निकर्षजन्यं ज्ञानं प्रत्यक्षम्। तद्विद्विधम्। निर्विकल्पकं सविकल्पकञ्चेति। तत्र निष्प्रकारकं ज्ञानं निर्विकल्पकम्। सप्रकारकं ज्ञानं सविकल्पकम्। यथा डित्थोऽयम्। बाह्यणोऽयम्। श्यामोऽयं पाचकोऽयमिति॥

*tatra pratyakṣajñānakaraṇam pratyakṣam. indriyārthasa-  
nnikarṣajanyam jñānam pratyakṣam. tadvividham. nirvi-  
kalpakam savikalpakañceti. tatra niṣprakārakam jñānam  
nirvikalpakam. saprakārakam jñānam savikalpakam. yathā  
dittho 'yam. brāhmaṇo 'yam. śyāmo 'yam pācako 'yamiti.*

**Translation: 39**

*Pratyakṣa is the instrument or process of perceptual cognition. A perceptual cognition is that cognition which is produced by the contact between the sense organ and the object. That is of two kinds: non-verbalizable and verbalizable. A non-verbalizable cognition is that which does not present its content in the form of qualifier and qualificand. A verbalizable cognition on the other hand is that cognition which reflects its content in the form of qualifier and qualificand type. For example this is X (dittha); He is a brāhmin; He is black; He is a cook, and so on.*

**Notes: 39**

The process of acquiring the cognition of the world directly by the sense-organs is called pratyakṣa-pramāṇa and the resultant cognition produced by such process is called pratyakṣa-jñāna.

The factors involved in this process are self, mind, senses and their objects. Self gets connected with the mind, mind with the sense, sense with its object and what immediately emerges is an indeterminate perceptual cognition and this cognition produced a determinate perceptual cognition. An indeterminate cognition is called nirvikalpaka-pratyakṣa and a determinate cognition is called savikalpaka-pratyakṣa. An indeterminate cognition cannot be expressed in language whereas a determinate cognition can be verbalized in language.

An indeterminate perception cannot be expressed in language because the content of an indeterminate cognition does not reflect a structure of qualifier-and qualified (dharma-dharmi-bhāvāpanna). Suppose, one sees a flower, the first perception that arises may be presented something like the following:

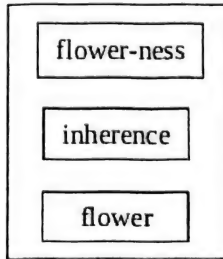

Here, all the three entities appear in the cognition, but they do not reflect a structure. But this cognition produces another cognition where the content reflects the structure clearly. The same indeterminate cognition produces the following cognition.

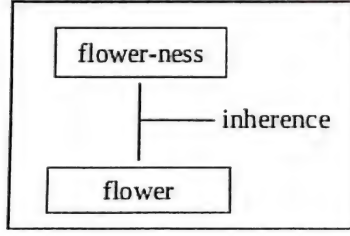

This is a flower

Here, the content-structure is very clear. It has reflected that 'flowerness' appears as the qualifier, 'inherence' as the relation and the locus of flowerness as 'flower'. That is, only such cognitions which are also called savikalpaka-jñāna are verbalizable in language.

The nirvikalpaka-jñāna is said to be the cause of savikalpaka-jñāna.

A determinate cognition is also called viśiṣṭa-jñāna where qualifier, qualificand and the relation between them are reflected. For a qualified cognition the knowledge of the qualification is the cause and a cause has to precede its effect. Therefore, an indeterminate cognition precedes a determinate cognition. An indeterminate cognition is inferred. It cannot be perceived by even mind.

### **Text: 40**

प्रत्यक्षज्ञानहेतुः इन्द्रियार्थसन्निकर्षः षड्विधः। संयोगः संयुक्तसमवायः  
 संयुक्तसमवेतसमवायः समवायः समवेतसमवायो विशेषणविशेष्यभावश्च।  
 चक्षुषा घटप्रत्यक्षजनने संयोगः सन्निकर्षः। घटरूपप्रत्यक्षजनने संयुक्त-  
 समवायः सन्निकर्षः चक्षुःसंयुक्ते घटे रूपस्य समवायात्। रूपत्वसामान्य-  
 प्रत्यक्षे संयुक्तसमवेतसमवायः सन्निकर्षः चक्षुःसंयुक्ते घटे रूपं समवेतं

तत्र रूपत्वस्य समवायात्। श्रोत्रेण शब्दसाक्षात्कारे समवायः सन्निकर्षः।  
कर्णविवरवृत्त्याकाशस्य श्रोत्रत्वात्। शब्दस्याकाशगुणत्वाद् गुणगुणिनोश्च  
समवायात्। शब्दत्वसाक्षात्कारे समवेतसमवायः सन्निकर्षः श्रोत्रसमवेते  
शब्दे शब्दत्वस्य समवायात्। अभावप्रत्यक्षे विशेषणविशेष्यभावः सन्निकर्षो  
घटाभाववद्भूतलमित्यत्र चक्षुःसंयुक्ते भूतले घटाभावस्य विशेषणत्वात्।  
एवं सन्निकर्षषट्कजन्यं ज्ञानं प्रत्यक्षम्। तत्करणमिन्द्रियम्। तस्मादिन्द्रियं  
प्रत्यक्षप्रमाणमिति सिद्धम्॥ इति प्रत्यक्षपरिच्छेदः।

*pratyakṣajñānahetuḥ indriyārthasannikarṣaḥ śaḍvidhaḥ.  
saṁyogaḥ saṁyuktasamavāyaḥ saṁyuktasamavetasama-  
vāyaḥ samavāyaḥ samavetasamavāyo viśeṣaṇaviśeṣyabhā-  
vaśca. cakṣuṣā ghaṭapratyakṣajanane saṁyogaḥ sannikar-  
ṣaḥ. ghaṭarūpapratyakṣajanane saṁyuktasamavāyassanni-  
karṣaḥ cakṣuḥsaṁyukte ghaṭe rūpasya samavāyāt. rūpatva-  
sāmānyapratyakṣe saṁyuktasamavetasamavāyaḥ sannikar-  
ṣaḥ cakṣuḥsaṁyukte ghaṭe rūpaṁ samavetaṁ. tatra  
rūpatvasya samavāyāt. śrotreṇa śabdāsākṣātkāre sama-  
vāyaḥ sannikarṣaḥ karṇavivaravṛtṭyākāśasya śrotratvāt.  
śabdasyākāśaguṇatvāt guṇaguṇinośca samavāyāt. śabdatva-  
sākṣātkāre samavetasamavāyaḥ sannikarṣaḥ śrotrasama-  
vete śabde śabdatvasya samavāyāt. abhāvapratyakṣe viśe-  
ṣaṇaviśeṣyabhāvaḥ sannikarṣo ghaṭābhāvavadbhūtalami-  
tyatra cakṣusaṁyukte bhūtale ghaṭābhāvasya viśeṣaṇatvāt.  
evaṁ sannikarṣaṣaṭkajanyam jñānam pratyakṣam. tatka-  
raṇamindriyam. tasmādindriyaṁ pratyakṣapramāṇamiti  
siddham. iti pratyakṣaparicchedaḥ.*

### **Translation: 40**

The contact between a sense-organ and its object which is the cause of perceptual cognition is of six types:

- (i) contact (*saṁyoga*)
- (ii) contact-cum-inherence (*saṁyukta-samavāya*)
- (iii) contact-cum-inherence-cum-inherence  
(*saṁyukta-samaveta-samavāya*)
- (iv) inherence (*samavāya*)
- (v) inherence-cum-inherence (*samaveta-samavāya*)
- (vi) the relationship of qualifier and qualificand type  
(*viśeṣaṇa-viśeṣyabhāva*)

*Saṁyoga* is that contact by which our eyes produce the perception of a pot. With reference to colour of pot contact-cum-inherence is the connection (*sannikarṣa*). Because, the colour in the pot which is connected with the eyes exists in the pot by the relation of inherence. With reference to the perception of universal called colourness the contact-cum-inherence-cum-inherence is the connection. Because, the colour exists by inherence in the pot which is connected with the eyes and in the colour colourness exists by the relationship of inherence. With reference to perception of sound by the ears the inherence is the connection. Because, ears are nothing but the ether in the hole of the ears and sound is the quality of the ether and inherence is the relationship between quality and the substance. With reference to perception of soundness inherence-cum-inherence is the connection because, in the sound which is inherent in the ears the soundness exists by inherence. With reference to perception of the negative entity called 'absence' the connection is the relationship of

qualifier and qualificand. For instance, when we look at the ground and say, there is no pot on the ground our eyes are connected with the ground and on that ground the absence of pot appears as a qualifier. Thus, a perceptual cognition is that cognition which is produced by these six types of connections (between the sense organ and its object). The instrument or process of that perception is our senses. That is why, sense organs are called *pratyakṣa-pramāṇa*.

**Notes: 40**

The six contacts with the sense-organs can be shown as follows: Suppose, it is the case of perceiving the flower, the contact of the eyes with the flower will be the contact:

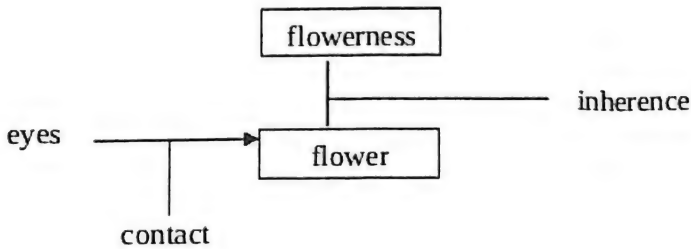

If one sees the red colour of the flower the contact will be the following:

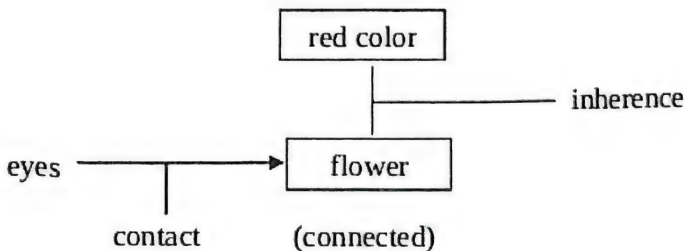

If one sees the universal of red colour, the following will be the contact:

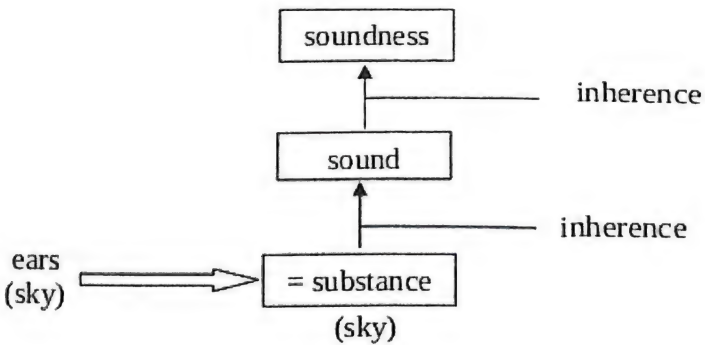
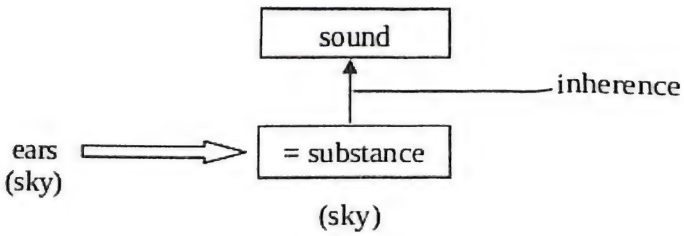
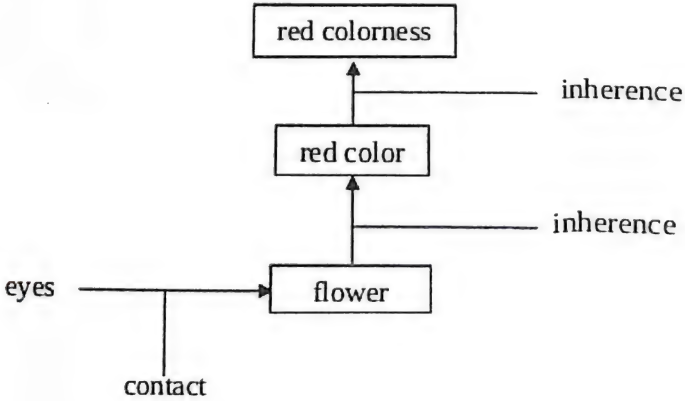



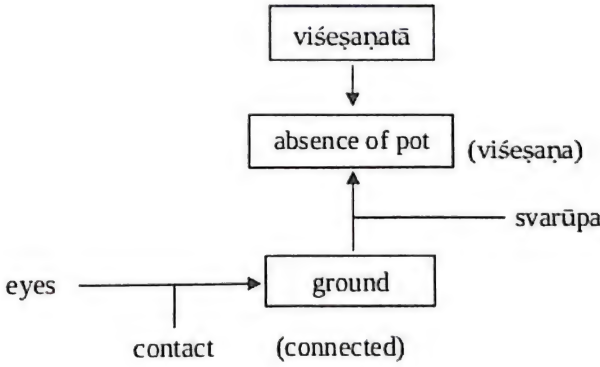

Here, the eyes are connected with the ground and 'the absence of pot' appears as a qualification to the ground because we say 'ghaṭābhāvavadbhūtaḥ' 'the ground qualified by the absence of pot.' Hence, the contact between the eyes and the absence of pot will be cakṣuḥ-saṁyukta-viśeṣaṇatā.

All these six types of contacts are the functions of the sense-organs and according to the second notion of instrumentality, the senses will become the pratyakṣa-pramāṇa since they are vyāpārat.

### **Text: 41**

अनुमितिकरणमनुमानम्। परामर्शजन्यं ज्ञानमनुमितिः। व्याप्तिविशिष्टपक्ष-  
धर्मताज्ञानं परामर्शः। यथा वह्निव्याप्यधूमवानयं पर्वत इति ज्ञानं परामर्शः।  
तज्जन्यं पर्वतो वह्निमानिति ज्ञानमनुमितिः। यत्र धूमस्तत्राग्निरिति साह-  
चर्यनियमो व्याप्तिः। व्याप्यस्य पर्वतादिवृत्तित्वं पक्षधर्मता॥

*anumitikaraṇamanumānam. parāmarśajanyam jñānama-  
numitiḥ. vyāptiviśiṣṭa-pakṣadharmatājñānam parāmarśaḥ.  
yathā vahnivyāpyadhūmavān ayaṁ parvata iti jñānam*

*parāmarśaḥ. tajjanyaṁ parvato vahnimāniti jñānamanu-  
mitiḥ. yatra dhūmastatrāgniriti sāhacaryaniyamo vyāptiḥ.  
vyāpyasya parvatādivṛttitvaṁ pakṣadharmatā.*

**Translation: 41**

The instrument or the process which produces the inferential cognition is called anumāna. An inferential cognition is that cognition which is produced by a confirmatory 'cognition' (parāmarśa). A confirmatory cognition is that cognition which reveals the existence of probans qualified by the invariable relationship called vyāpti on the subject (pakṣa). For example the 'cognition' viz. 'this mountain possesses smoke which is pervaded by fire' is a confirmatory 'cognition.' The cognition produced by that viz. 'this mountain possesses fire' will be an inferential 'cognition'. 'Wherever there is smoke, there is fire,' this type of invariable relationship of collocation is called vyāpti. The existence of the pervaded (vyāpya) on the mountain is called pakṣa-dharmatā.

**Notes: 41**

We can know say, 'fire' through our eyes and if some one keeps the same fire beyond the range of our eyes, in a bush and if you say we see the smoke produced by that fire, again we can know the same 'fire'. The first knowledge of fire is called perceptual knowledge of fire. Why? Because the process through which the second knowledge of fire has arisen is different from the process through which the first knowledge arose. In the case of first knowledge, there was direct contact of the sense organ with the fire, but in

the second case, in spite of the absence of direct contact, there has arisen the knowledge of fire. Therefore, it is the process that contributes to the difference in the genre of a cognition or knowledge. The second process is the process of inference in the above case. When there is a process it has to have a sequence or steps. The Indian logicians have identified the following steps in this process:

After a person has acquired the knowledge of the invariable relationship between 'smoke' and 'fire' through repeated observations sees a 'smoke' on the mountain, the process begins.

Step I: seeing the smoke on the mountain

Step II: remembering the invariable relationship  
between the smoke and the fire.

Step III: confirming that such a smoke which possesses  
that relationship exists on the mountain.

Step IV: concluding that there is 'fire' on the mountain.

This is a psychological process in the sense that the observer of 'smoke' has come to the conclusion that 'there is fire on the mountain' mentally. To put it diagrammatically:

Step I:

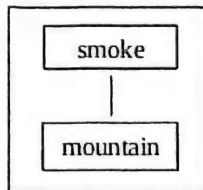

(The mountain has smoke)

Step II:

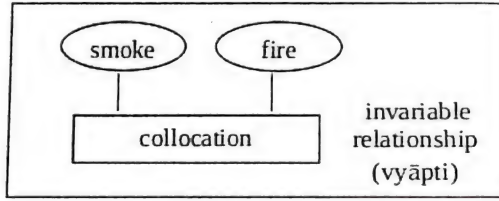

(The remembrance of vyāpti)

Step III:

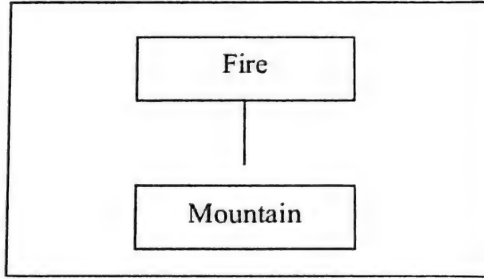

(parāmarśaḥ)

Step IV:

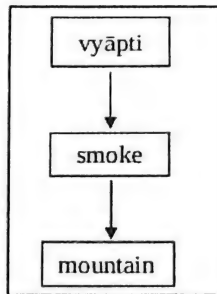

(There is fire on the mountain)

**Text: 42**

अनुमानं द्विविधं स्वार्थं परार्थञ्च। स्वार्थं स्वानुमितिहेतुः। तथाहि स्वयमेव भूयो दर्शनेन यत्र धूमस्तत्राग्निरिति महानसादौ व्याप्तिं गृहीत्वा पर्वतसमीपं गतस्तद्गते चाग्नौ सन्दिहानः पर्वते धूमं पश्यन् व्याप्तिं स्मरति यत्र धूमः तत्राग्निरिति। तदनन्तरं वह्निव्याप्यधूमवानयं पर्वत इति ज्ञानमुत्पद्यते। अयमेव लिङ्गपरामर्श इत्युच्यते। तस्मात्पर्वतो वह्निमानिति ज्ञानमनुमितिरुत्पद्यते। तदेतत्स्वार्थानुमानम्।

यत्तु स्वयं धूमादग्निमनुमाय परप्रतिपत्त्यर्थं पञ्चावयववाक्यं प्रयुङ्क्ते तत्परार्थानुमानम्। यथा पर्वतो वह्निमान् धूमवत्त्वात्। यो यो धूमवान्स वह्निमान् यथा महानसः। तथा चायम्। तस्मात्तथेति। अनेन प्रतिपादितात् लिङ्गात्परोऽप्यग्निं प्रतिपद्यते।

प्रतिज्ञाहेतूदाहरणोपनयनिगमनानि पञ्चावयवाः। पर्वतो वह्निमानिति प्रतिज्ञा। धूमवत्त्वादिति हेतुः। यो यो धूमवान्स सोऽग्निमान् यथा महानस इत्युदाहरणम्। तथा चायमित्युपनयः। तस्मात्तथेति निगमनम्। स्वार्थानुमितिपरार्थानुमित्योर्लिङ्गपरामर्श एव करणं तस्माल्लिङ्गपरामर्शोऽनुमानम्॥

*anumānam dvividham svārtham parārthañca. svārtham svānumitihetuḥ. tathāhi svayameva bhūyo darśanena yatra dhūmastatrāgniriti mahānasādau vyāptim gṛhītvā parvata-samīpam gatastadgate cāgnau sandihānaḥ parvate dhūmaṁ paśyan vyāptim smarati yatra dhūmaḥ tatrāgniriti. tadanantaram vahnivyāpyadhūmavānayaṁ parvata iti jñānamutpadyate. ayameva liṅgaparāmarśa ityucyate. tasmāt parvato vahnimāniti jñānamanumitirutpadyate. tadetat svārthānumānam.*

*yattu svayam dhūmādagnimanumāya parapratipattyartham pañcāvayavavākyaṁ prayuṅkte tatparārthānumānam. yathā parvato vahnimān dhūmavatvāt. yo yo dhūmavānsa*

*vahnimān yathā mahānasaḥ. tathā cāyam. tasmāttatheti. anene pratipāditāt liṅgāt paro'pyagnim pratipadyate.*

*pratiññāhetūdāharaṇopanayanigamanāni pañcāvayavāḥ parvato vahnimāniti pratiññā. dhūmavattvāditi hetuḥ. yo yo dhūmavānsa so'gnimān yathā mahānasa ityudāharaṇam. tathā cāyamityupanayaḥ. tasmāttatheti nigamanam. svārthānumitiparārthānumitiyorliṅgaparāmarśa eva karaṇam. tasmālliṅgaparāmarśo'numānam.*

**Translation: 42**

Anumāna or inference is of two types: (i) called *svārtha* (for convincing oneself) and (ii) *parārtha* (for convincing others). The first variety i.e. *svārtha* is the cause of inferential 'cognition' for oneself. To explain, when someone through repeated observation viz. wherever there is smoke there is fire as in kitchen etc. grasps the invariable relationship between smoke and fire, approaches a mountain and looks at the smoke on the mountain, initially he is in a doubt, whether there is fire in the mountain and consequently remembers the invariable relationship viz. 'wherever there is smoke there is fire.' And after that a 'cognition' viz. 'this mountain possesses smoke which is pervaded by fire' arises in him. This very 'cognition' is technically called *liṅga-parāmarśa*. After this 'cognition' the inferential 'cognition' 'the mountain possesses fire' arises. This is the process of *svārtha-anumāna*.

After having inferred fire on the basis of a smoke when someone wants to convince others by using

a set of five sentences that process of inference is called *parārtha-anumāna*. For example: (i) the mountain possesses fire (ii) because it possesses smoke (iii) whatever possesses smoke possesses fire e.g. kitchen (iv) such is this (mountain) (v) therefore, this mountain possesses fire. By this set of five sentences when the ground (*liṅga*) is stated even others can come to know fire. These five sentence are technically called by five names such as, (i) *pratijñā* (roughly a proposition) (ii) *hetu* (ground or mark or reason) (iii) *udāharaṇa* (example) to demonstrate the invariable relationship between probans and probandum (iv) *upanaya* (confirmatory sentence) (v) *nigamana* (conclusion).

Thus, the mountain possesses fire is *pratijñā* because it possesses smoke is *hetu*, whatever possesses smoke, possesses fire, kitchen is an *udāharaṇa* such is the mountain is called *upanaya*, therefore, this mountain possesses fire is *nigamana*. The instrument or process of both the inferential cognition produced by *svārtha-anumāna* and the inferential cognition produced by *parārtha-anumāna* is nothing but the confirmatory cognition namely, *liṅga-parāmarśa*. That is why, *liṅga-parāmarśa* is called *anumāna*.

### **Notes: 42**

When the process is mental i.e. when someone is mentally deducing for one's own knowledge, the process is called *svārthānumāna*. But once he is convinced and when he tries to convince others he utters a set of five sentences

and this set of five sentences is a process and this process is called parārthānumāna, the process through which one tries to convince others.

Each sentence of this set is a part or a step in that process and hence it is called an avayava (part of the process).

The five steps in this process are:

Step I: the claim or the statement that is going to be proved (pratijñā).

Step II: the ground for the claim.

Step III: example to demonstrate the invariable relationship between the ground and the claim.

Step IV: confirming that the ground provided does have such relationship and such a ground is present in the case under consideration.

Step V: confirming the claim.

Although these steps are five sentences, the process is not the process of śabdapramāṇa. Each sentence generates śābdabodha no doubt, but that understanding is a step that contributes to the next step in the process of inference. That is why, the five sentences together is called a single sentence (pañcāvayava-vākya). Therefore, here the terms vākya should not be taken in the ordinary sense of a sentence, but in the sense of inferential process, the process of deduction. There is a traditional debate with the Bhāṭṭa school of Pūrvamīmāṃsā regarding the number of steps in inferential process.



While the Indian logicians insist that all the five steps mentioned above are absolutely necessary, the Bhāṭṭa school thinks that either the first three steps from the beginning or the last three steps starting from example will be sufficient to account for the entire process.

I personally think that the Indian logician's stand is more rational because it leads to establish a universal theory of inference applicable to all cases uniformly. For further reading one can look into Śāśadhara's *Parāmarśavāda* included in his *Nyāyasiddhāntadīpa*.

### **Text: 43**

लिङ्गं त्रिविधम्। अन्वयव्यतिरेकि केवलान्वयि केवलव्यतिरेकि च। अन्वयेन व्यतिरेकेण च व्याप्तिमदन्वयव्यतिरेकि। यथा वह्नौ साध्ये धूमवत्त्वम्। यत्र धूमस्तत्राग्निर्यथा महानस इत्यन्वयव्याप्तिः। यत्र वह्निः नास्ति तत्र धूमोऽपि नास्ति यथा महाहृद इति व्यतिरेकव्याप्तिः। अन्वय-मात्रव्याप्तिकं केवलान्वयि। यथा घटोऽभिधेयः प्रमेयत्वात्पटवत्। अत्र प्रमेयत्वाभिधेयत्वयोर्व्यतिरेकव्याप्तिर्नास्ति सर्वस्यापि प्रमेयत्वादभिधेय-त्वाच्च। व्यतिरेकमात्रव्याप्तिकं केवलव्यतिरेकि। यथा पृथिवीतरेभ्यो भिद्यते गन्धवत्त्वात्। यदितरेभ्यो न भिद्यते न तद्गन्धवत्। यथा जलम्। न चेयं तथा। तस्मान्न तथेति। अत्र यद् गन्धवत्तदितरभिन्नमित्यन्वयदृष्टान्तो नास्ति। पृथिवीमात्रस्य पक्षत्वात्॥

*liṅgam trividham. anvayavyatireki kevalānvayi kevalavyati-  
reki ca. anvayena vyatirekeṇa ca vyāptimadanvayavyatireki  
yathā vahnau sādhye dhūmavattvam. yatra dhūmaḥ tatrā-  
gniryathā mahānasa ityanvayavyāptiḥ. yatra vahnirnāsti  
tatra dhūmo 'pi nāsti yathā mahāhrada iti vyatirekavyāptiḥ.  
anvayamātravyāptikam kevalānvayi. yathā ghaṭo 'bhidheyo*

*prameyatvātapaṭavad. atra prameyatvābhidheyatvayorvyati-  
rekavyāptirnāsti sarvasyāpi prameyatvādabhidheyatvācca.  
vyatirekamātravyāptikaṁ kevalavyatireki. yathā pṛthivīta-  
rebhyo bhidyate gandhavattvāt. yaditarebhyo na bhidyate  
na tadgandhavat yathā jalam. na ceyam tathā. tasmānna  
tatheti. atra yadgandhavat taditarabhinnam iti anvaya-  
dr̥ṣṭānto nāsti. pṛthivīmātrasya pakṣatvāt.*

**Translation: 43**

A liṅga or mark or ground or reason is of three types (i) anvayavyatirekin, (which exhibits both positive and negative concomitance) (ii) kevalānvayin (which exhibits only positive concomitance), and (iii) kevalavyatirekin (which demonstrates only negative concomitance). Anvayavyatirekin is that ground which possesses both the positive and negative concomitance e.g. when fire is to be established on the basis of smoke, smoke is said to be such ground. Here, it can be demonstrated that wherever there is smoke there is fire as in the case of kitchen. And it can also be demonstrated where there is no fire there is no smoke as in a big lake (the first is the demonstration of positive concomitance and the second is the demonstration of negative concomitance). The kevalānvayin ground is that ground which possesses only positive concomitance e.g. when we infer the “pot is expressible in language because it is an object of a true cognition” like a cloth. Here, one cannot demonstrate the negative concomitance between the “state “of being the object of true cognition” and the “state of being expressible in language” because

everything in this universe is both content or object of a true cognition and it is expressible in language.

*Kevalavyatirekin* is that ground which possesses negative concomitance only. For instance, when one infers “earth is different from non-earth” because, it possesses smell. Whatever is not different from non-earth does not possess smell e.g. water. The earth is not like that and therefore, it is not different from non-earth. Here, there is no example to demonstrate ‘whatever possess smell is different from non-earth.’ Because the entire earth is the subject (*pakṣa*).

### **Notes: 43**

A ground (*liṅga*), the knowledge of which leads to the knowledge of probandum (*sādhya* or *liṅgin*) is of three types because it has those types of relationship (*vyāpti*) with the probandum.

In the first kind of relationship one can demonstrate the following:

*yatra yatra hetuḥ tatra tatra sādhyam* and also

*yatra sādhyam nāsti tatra hetuḥ nāsti*

Here, the first statement is called the statement of *anvaya-vyāpti* and the second one, the statement of *vyatireka-vyāpti*.

‘Wherever there is x, there is y’, if it is true, the relationship is called *anvaya-vyāpti*.

But ‘where there is no x, there is no y’ if it is true, it is said to have *vyatireka-vyāpti*.

If it is so then in the above example of inferring fire on the basis of smoke, why is the vyatireka demonstration not made as: *yatra dhūmaḥ nāsti tatra vahniḥ nāsti?*

The reason behind this is the following fact:

(a) In some cases, the area of existence of the ground and that of a probandum are one and the same. For instance, if someone wants to establish 'non eternality (anityatva) on the basis of its 'being a product' (kṛtakatva) one can demonstrate the positive (anvaya) and negative (vyatireka) relations without any problem.

yatra yatra kṛtakatvam tatra tatra anityatvam as is the case of a pot and also yatra yatra kṛtakatvam nāsti tatra tatra anityatvam nāsti as in the case of 'sky'.

There is no need of saying here yatra yatra anityatvam nāsti tatra tatra kṛtakatvam nāsti. Because, it is a case of sama-vyāpti which can be demonstrated as follows:

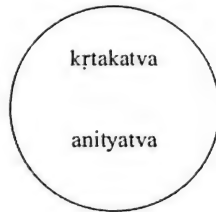

Here the same circle is the area of kṛtakatva and the same is the area of anityatva. Therefore, the relationship between them is symmetrical.

But the case of inferring 'fire' on the basis of 'smoke' does not hold the symmetrical relationship. The relationship between smoke and fire is of the following type:

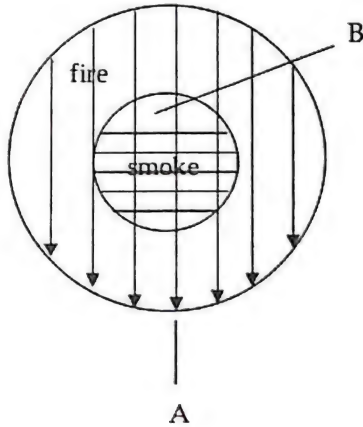

The area of fire is the entire circle of A, but the area of smoke is the circle of B. It means 'fire' exists in the area of smoke also whereas smoke does not exist in the area of 'fire'. Therefore, I can say, wherever there is 'smoke', there is 'fire', but I cannot say 'wherever there is no 'smoke', there is no 'fire', since there are cases where 'fire' remains without smoke such as ' a hot iron ball' (tapta-ayogolaka).

In order to include both, symmetrical as well as a-symmetrical relationship, the Indian logician proposed the following form of testing relationships:

Wherever there is x, there is y and wherever there is no y, there is no x.

This can be applicable to both *kṛtakatva* as well as 'smoke'.

But there is a case where the method cannot be applicable even though it is a case of symmetrical relationship. For instance, the case of inferring knowability on the basis of 'namability' or vice-a-versa.

Although anvaya-statement is possible here, the vyatireka-statement is not possible because no example can be cited to demonstrate such a relationship.

Similarly, there is a case where a vyatireka statement alone is possible to be demonstrated, and not the anvaya-statement. For instance, when someone infers 'This earth is different from all that is not earth, because it has smell.'

Here, anvaya-statement is not possible since the entire earth is taken here as pakṣa and an example must be different from the pakṣa which is not possible in this case.

That is why, a ground is said to be of three types:

- (1) anvaya-vyatirekin, like 'smoke'
- (2) kevala-anvayin, like knowability or namability and
- (3) kevala-vyatirekin, like 'smell' in the respective cases mentioned above.

In other words, the first variety of ground has both, the positive as well as the negative concomitance (vyāpti), the second type of ground has only the positive concomitance and the third type has only negative concomitance.

### **Text: 44**

सन्दिग्धसाध्यवान्पक्षः। यथा धूमवत्त्वे हेतौ पर्वतः। निश्चितसाध्यवान् सपक्षः। यथा तत्रैव महानसः। निश्चितसाध्याभाववान्विपक्षः। यथा तत्रैव महाहृदः॥

*sandigdhasādhyavān pakṣaḥ. yathā dhūmavattve hetau parvataḥ. niścitasādhyavān sapakṣaḥ. yathā tatraiva mahā-*

*nasah. niścitasādhyābhāvavānvipakṣah. yathā tatraiva mahāhradaḥ.*

**Translation: 44**

A pakṣa is that which possesses probandum about which there is doubt. For example, when fire is to be inferred the mountain on the basis of smoke, mountain is called pakṣa. Sapakṣa is that which possesses the probandum where there is no doubt about its existence. For instance in the same above example, the kitchen is called sapakṣa. Vipakṣa is that which possesses the absence of probandum about which there is no doubt. For instance in the same example the big lake is called vipakṣa.

**Notes: 44**

Pakṣa is that locus where the sādhyā is to be established. This may be called the subject where the sādhyā is predicated.

The doubtful locus of the sādhyā is a pakṣa. This is an older idea of pakṣa. According to the newer idea, a pakṣa is that which possesses pakṣatā, and the pakṣatā is formulated in the following way:

Pakṣatā = the absence of the knowledge of the sādhyā qualified by the absence of the desire to establish the sādhyā.

Suppose, the desire to establish the sādhyā is A; and the knowledge of sādhyā is B, in that case the definition of pakṣatā can be put as follows:

$$- ( - A + B ) = \text{pakṣatā}$$

where '+' stands for viśiṣṭa and '-' stands for absence.

It implies that there can be four possibilities when there are two variables:

$$(a) + A + B$$

$$(b) + A - B$$

$$(c) - A + B$$

$$(d) - A - B$$

(a) reads there is desire to prove the sādhyā and there is knowledge of sādhyā.

(b) says that there is desire to prove and there is no knowledge of sādhyā.

(c) says that there is no desire to prove and there is already the knowledge of sādhyā and

(d) reads that there is neither the desire to prove nor there is knowledge of sādhyā.

The formulation of  $- (- A + B)$  will indicate (a), (b) and (d) and in all these three cases there will be inference. In the case of (c), however, the inferential process will not work because the sādhyā is already known and there is no desire to know either.

The most important factor is the desire to prove. If there is desire, irrespective of the fact, whether the sādhyā is known or not, the process of inference will work. Sometimes, in spite of the absence of desire, if there is no knowledge of sādhyā the inferential process works.

When some one is inside a room and comes to know that there are clouds in the sky on the basis of the sound of lightening it will be the example of (d); when there is



knowledge of fire on the basis of smoke, it is an example of (b) and if someone asks to prove fire again in spite of the knowledge of fire, it will be an example of (a).

Sapakṣa is a locus like kitchen where the co-existence of smoke with fire is known.

Vipakṣa is the locus where it is known, for certain, that the sādhyā does not exist. For instance, the lake where it is known that 'fire' does not exist.

The popular example of an inference is as follows:

- (1) The mountain possesses fire
- (2) Because it has smoke
- (3) Whenever there is smoke, there is fire like a kitchen
- (4) There is such a smoke which is pervaded by fire on this mountain.
- (5) Therefore, there is fire on the mountain

To put it diagrammatically:

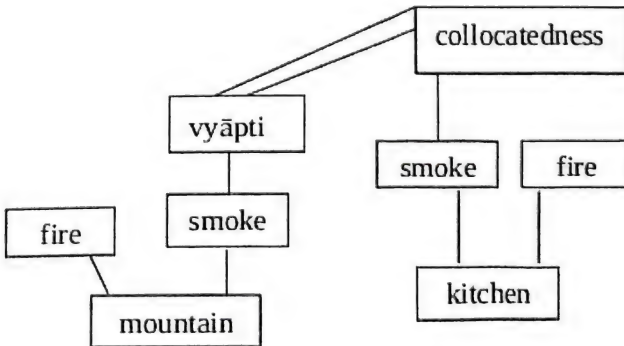

(The mountain has fire, because it has smoke)

**Text: 45**

सव्यभिचारविरुद्धसत्प्रतिपक्षासिद्धबाधिताः पञ्च हेत्वाभासाः ॥

*savyabhicāra-viruddha-satpratipakṣa-asiddha-bādhitāḥ  
pañca hetvābhāsāḥ.*

**Translation: 45**

There are five types of fallacious grounds viz.

- (i) *savyabhicāra* (which suffers from inconsistency)
- (ii) *viruddha* (opposite)
- (iii) *satpratipakṣa* (which has parallel counter-argument)
- (iv) *asiddha* (unestablished or unknown) and
- (v) *bādhita* (contradicted).

**Notes: 45**

There is a notion of a good ground and a bad ground. A good ground is that the knowledge of which leads to the knowledge of *sādhya*. A bad ground does not do that job. A good ground is called *sad-hetu* and a bad ground is called *asad-hetu*. A *sad-hetu* is that which possesses an invariable relationship with *sādhya* and an *asad-hetu* is that which does not possess such a relationship and hence can be called a fallacious ground. Bad grounds are of five types which will be illustrated in the next text 46.

*Savyabhicāra* means 'inconsistent', 'variable' 'irregular'. Knowledge of such a ground cannot generate inferential knowledge.

For instance, one cannot know smoke from the knowledge of fire, because it is not true that wherever there

is fire, there is smoke. In other words, fire does not have invariable relationship with smoke because fire can remain without smoke. Hence, 'fire' will be treated as an *asad-hetu* for knowing 'smoke'.

*Viruddha* means 'opposite' or 'contradictory'. Such a ground proves just opposite of what is intended to be proved. For example, if some one says that 'the pot is eternal, because it is 'produced', the ground namely, 'the fact that' it is produced will prove that the pot is not eternal, which is just opposite of what is intended to be produced.'

*Sat-prati-pakṣa* means 'which has a counter ground to disprove what is intended to be proved.' For instance, if a *Mīmāṃsaka* says that 'sound is eternal because it is an object of auditory perception like soundness, the *Naiyāyikas* may forward another ground namely, 'the fact that sound is an effect' which will disprove what was intended to be proved by the *Mīmāṃsakas*.

*Asiddha* means 'unestablished or unknown'. Thus, if someone says that knowledge is a quality because it is an object of visual perception, he cannot prove it because the ground given itself is not established or known since knowledge can be known only by mind and not by eyes.

*Bādhita* means 'already known to be false by some other process of knowing'. For example, if some one says that fire is cold, because it is a substance, he cannot establish it because one can verify by touching fire that what is intended to be established is not true. In a broad

way, this is the idea behind an *asad-hetu* that it cannot lead one to establish the *sādhya* which is intended to be established on the basis of that ground or *hetu*. The details of this are discussed in the texts from 46 to 50.

**Text: 46**

सव्यभिचारोऽनैकान्तिकः। स त्रिविधः। साधारणासाधारणानुपसंहारि-  
भेदात्। तत्र साध्याभाववृत्तिः साधारणोऽनैकान्तिकः। यथा पर्वतो वह्नि-  
मान्प्रमेयत्वादिति प्रमेयत्वस्य वह्न्यभाववति हृदे विद्यमानत्वात्। सर्व-  
सपक्षविपक्षव्यावृत्तोऽसाधारणः। यथा शब्दो नित्यः शब्दत्वादिति। शब्दत्वं  
सर्वेभ्यो नित्येभ्योऽनित्येभ्यश्च व्यावृत्तं शब्दमात्रवृत्ति। अन्वयव्यतिरेक-  
दृष्टान्तरहितोऽनुपसंहारी। यथा सर्वमनित्यं प्रमेयत्वादिति। अत्र सर्वस्यापि  
पक्षत्वादृष्टान्तो नास्ति॥

*savyabhicāro 'naikāntikaḥ. sa trividhaḥ. sādharmaṇāsādhāra-  
ṇānupasamhāribhedāt. tatra sādhyābhāvavadvṛttiḥ sādhar-  
raṇo 'naikāntikaḥ. yathā parvato vahnimān prameyatvāditi  
prameyatvasya vahnnyabhāvavati hrade vidyamānatvāt. sar-  
vasapakṣavipakṣavyāvṛtto 'sādhāraṇaḥ. yathā śabda nityaḥ  
śabdatvāditi. śabdatvaṁ sarvebhyo nityebhyo 'nityebhyaśca  
vyāvṛttam śabdāmātravṛtti. anvayavyatirekadrṣṭāntarahito-  
'nupasamhārī. yathā sarvamanityaṁ prameyatvāditi. atra  
sarvasyāpi pakṣatvāddrṣṭānto nāsti.*

**Translation: 46**

The *savyabhicāra* is also called *anaikāntika*. That is of three types: (i) *sādhāraṇa* (inconsistent in a general way) (ii) *asādhāraṇa* (inconsistent in a unique way) and (iii) *anupasamhārin* (inconclusive). The *sādhāraṇa* type of fallacious ground is that which exists in a locus where

there is no probandum. For example if some one says the mountain has fire because it has the state of being the object of true cognition the ground viz. the state of being an object of true cognition is a fallacious ground because the state of being the object of true cognition is also present in the lake where there is no fire. The *asādhāraṇa* type of fallacious ground is that which does not exist either in *sapakṣa* or in *vipakṣa*.

For instance, if some one says that sound is eternal because it has soundness, this ground will suffer from that defect. Here, the ground viz. soundness excludes all loci eternal and non-eternal and exists only in the sound. The *anupasaṁhārin* type of fallacious ground is that which is devoid of examples which can demonstrate positive and negative concomitance. For example if someone says all this is non-eternal because it has the state of being the object of a true cognition, such a ground suffers from that defect. Here, since everything becomes subject (*pakṣa*) no example can be given to demonstrate either positive or negative concomitance.

**Notes: 46**

Savyabhicāra is also called *anaikāntika*. It is of three types:

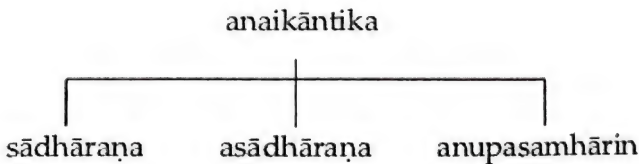

sādhāraṇa-type of an asad-hetu exists in a locus where the sādhyā does not exist.

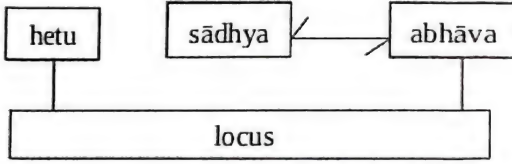

Such a hetu is sādhāraṇa

Asādhāraṇa-type of bad ground is that ground where it is not possible to demonstrate anvaya-vyāpti since there will be no sapakṣa.

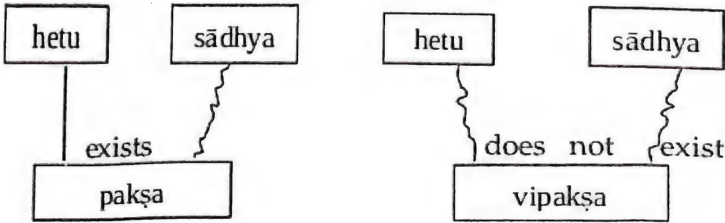

Although vyatireka-vyāpti can be demonstrated there is no sapakṣa to demonstrate anvaya-vyāpti.

Anupasaṁhārin-type of bad reason does not allow demonstration of both, the anvaya-vyāpti and vyatireka-vyāpti since there can neither be a sapakṣa nor a vipakṣa.

**Text: 47**

साध्याभावव्याप्तौ हेतुर्विरुद्धः। यथा शब्दो नित्यः कृतकत्वादिति। कृतकत्वं हि नित्यत्वाभावेनानित्यत्वेन व्याप्तम्॥

*sādhyābhāvavyāpto heturviruddhaḥ. yathā śabda nityaḥ  
kṛtakatvāditi. kṛtakatvam hi nityatvābhāvenānityatvena  
vyāptam.*

**Translation: 47**

*A viruddha type of fallacious ground is that ground which is pervaded by the absence of probandum. For example: When someone says sound is eternal because it is an effect like a pot, such a ground is said to be a viruddha ground. Here, the state of being an effect is indeed pervaded by non-eternity which is the absence of eternity.*

**Notes: 47**

It is not true that wherever there is 'effectness' there is 'eternity'. On the contrary, it is only true that wherever there is 'effectness' there is non-eternity. In this way, the ground given in the argument is pervaded by just opposite of what was intended to be proved on the basis of the ground of 'effectness'.

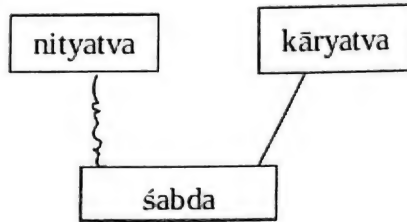

sādhyābhāva, here is nityatvābhāva and this pervades kāryatva. Hence this hetu is called viruddha.

Over and above the vyabhicāra-doṣa this hetu (kāryatva) is suffering here from the defect of virodha also.

**Text: 48**

यस्य साध्याभावसाधकं हेत्वन्तरं विद्यते स सत्प्रतिपक्षः। यथा शब्दो नित्यः श्रावणत्वात् शब्दत्ववदिति। शब्दोऽनित्यः कार्यत्वात् घटवदिति॥  
*yasya sādhyābhāvasādhakam hetvantaram vidyate sa sat-pratipakṣaḥ. yathā śabda nityaḥ śrāvaṇatvāt śabdatvavaditi. śabda'nityaḥ kāryatvāt ghaṭavaditi.*

**Translation: 48**

A satpratipakṣa kind of fallacious ground is that which has a parallel and balancing counter argument which can establish in fact the absence of probandum e.g. when the Mīmāṃsaka says 'sound is eternal because it is audible like soundness' the Naiyāyika will say sound is non-eternal because it is an effect like a pot.

**Notes: 48**

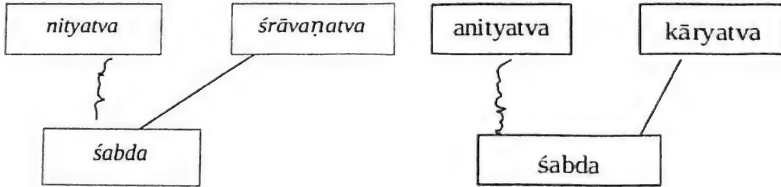

Here one ground (śrāvaṇatva) establishes that śabda is eternal and the other ground establishes that śabda is non-eternal. These are two contesting grounds. One ground, here, can be said to have an enemy in the form of another ground. As a result both fail to establish what is intended to be established, conclusively. No one wins in this debate.



**Text: 49**

असिद्धस्त्रिविधः। आश्रयासिद्धः स्वरूपासिद्धो व्याप्यत्वासिद्धश्च। आश्र-  
यासिद्धो यथा गगनारविन्दं सुरभि अरविन्दत्वात् सरोजारविन्दवत्। अत्र  
गगनारविन्दमाश्रयः। स च नास्त्येव। स्वरूपासिद्धो यथा शब्दो गुणः चाक्षु-  
षत्वात्। अत्र चाक्षुषत्वं शब्दे नास्ति शब्दस्य श्रावणत्वात्। सोपाधिको हेतुः  
व्याप्यत्वासिद्धः। साध्यव्यापकत्वे सति साधनाव्यापकत्वमुपाधिः। साध्य-  
समानाधिकरणात्यन्ताभावाप्रतियोगित्वं साध्यव्यापकत्वम्। साधनवन्नि-  
ष्ठात्यन्ताभावप्रतियोगित्वं साधनाव्यापकत्वम्। यथा पर्वतो धूमवान् वह्निम-  
त्त्वादित्यत्र आर्द्रेन्धनसंयोग उपाधिः। तथाहि। यत्र धूमस्तत्रार्द्रेन्धनसंयोग  
इति साध्यव्यापकता। यत्र वह्निः तत्रार्द्रेन्धनसंयोगो नास्ति अयोगोलके  
आर्द्रेन्धनसंयोगाभावादिति साधनाव्यापकता। एवं साध्यव्यापकत्वे सति  
साधनाव्यापकत्वाद् आर्द्रेन्धनसंयोग उपाधिः। सोपाधिकत्वाद्वह्निमत्त्वं  
व्याप्यत्वासिद्धम्॥

*asiddhastrividhaḥ. āśrayāsiddhaḥ svarūpāsiddho vyāpyatv-  
āsiddhaśca. āśrayāsiddho yathā gaganāravindam surabhi  
aravindatvāt sarojāravindavat. atra gaganāravindamāśra-  
yaḥ. sa ca nāstyeva. svarūpāsiddho yathā śabdo guṇaḥ  
cākṣuṣatvāt. atra cākṣuṣatvaṁ śabde nāsti śabdasya  
śrāvaṇatvāt. sopādhiko hetuḥ vyāpyatvāsiddhaḥ. sādhyav-  
vyāpakatve sati sādhanāvvyāpakatvamupādhiḥ. sādhyasa-  
mānādhikaraṇātyantābhāvāpratīyogitvaṁ sādhyavyāpaka-  
tvam. sādhanavanniṣṭhātyantābhāvāpratīyogitvaṁ sādha-  
nāvvyāpakatvam. yathā parvato dhūmavān vahnimattvādi-  
tyatrārdrendhanasamyoga upādhiḥ. tathāhi, yatra dhūmaḥ  
tatrārdrendhanasamyoga iti sādhyavyāpakatā. yatra vahnīḥ  
tatrārdrendhanasamyogo nāsti ayogolake ārdrendhanasam-  
yogābhāvāditi sādhanāvvyāpakatā. evaṁ sādhyavyāpakatve*

*sati sādhanāvvyāpakatvād ārdrendhanasam̐yoga upādhiḥ.  
sopādhiakatvādvahnimattvam̐ vyāpyatvāsiddham.*

**Translation: 49**

Asiddha is of three kinds: (i) āśrayāsiddha (ii) svarūpāsiddha and (iii) vyāpyatvāsiddha. The example for āśrayāsiddha is the sky lotus is fragrant because it is a lotus, like a lotus in the pond.' Here, the sky lotus is the locus of fragrance but that does not exist. The example for svarūpāsiddha will be 'sound is a quality because it can be grasped by eyes.'

Here, it is obvious that sound cannot be grasped by eyes, because sound can be grasped only by ears. Vyāpyatvāsiddha is that which is associated with some extraneous factor (upādhi). An upādhi is defined as 'that which pervades the probandum but does not pervade the probans.' The pervasion of probandum means not being the counter-positive of an absence which is collocated with the probandum and being not the pervader of the probans means the state of being the counter-positive of an absence which exists in the locus of probans.

To illustrate: In the case of inference viz. the mountain has smoke because it has fire, the contact with wet fuel is considered to be an upādhi. It can be seen that wherever there is smoke there is contact with wet fuel and hence the contact with the wet fuel pervades the smoke, but, it is not true that wherever there is fire there is contact with the wet fuel. For instance, in a red hot iron ball, there is no contact with wet fuel and still there is fire. Thus, the contact with

wet fuel which is the pervader of the probandum viz. smoke in the present case and non-pervader of the probans viz. fire in the present case becomes upādhi. Naturally, the ground fire will be declared as vyāpyatvāsiddha because it is associated with an upādhi.

**Notes: 49**

Inference does not work 'if any component of the process of inference is not established or known. Inference has three main components: (i) pakṣa where sādhyā is intended to be established; (ii) hetu by the knowledge of which the process of initiated and (iii) the relationship (vyāpti) the knowledge of which takes one to the knowledge of sādhyā. All these three are required to be known.

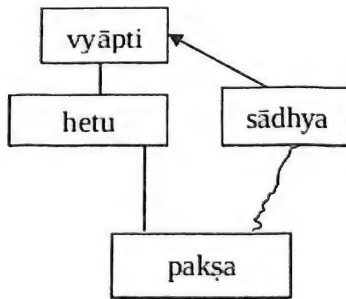

All these three must be known to initiate and complete the process of inference. If pakṣa is not known it results into pakṣāsiddhi or āśrayāsiddhi; if hetu is not known it will result into svarūpāsiddhi, and if vyāpti is not known it will lead to vyāpyatvāsiddhi.

Upādhi means an extraneous factor. When the colours of the flower is reflected in the crystal, the colour is treated as upādhi. The colour is not the intrinsic property of the crystal. In the same way, the vyāpti in the contact with the wet fuel (ārdrendhana-samyoga) appears in the fire qualified by the contact with the wet fuel in the inference of smoke on the ground of fire and that is why the contact with the wet fuel is treated as upādhi. This diagnosis explains why one does not get the knowledge of vyāpti in cases like 'There is smoke, because there is fire.'

The possibility of such a case is when the vyāpti is viṣama-vyāpti where the area of sādhyā or vyāpaka is wider than the area of hetu. To put it diagrammatically:

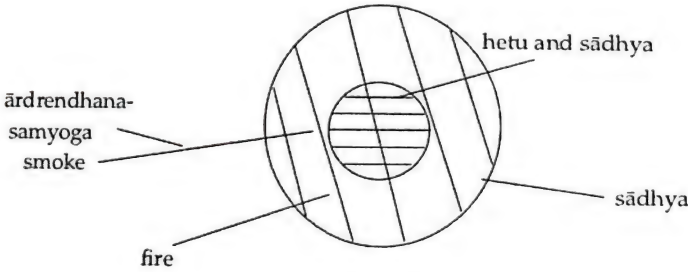

### **Text: 50**

यस्य साध्याभावः प्रमाणान्तरेण निश्चितः स बाधितः। यथा वह्निस्नुष्णो द्रव्यत्वादिति। अत्रानुष्णत्वं साध्यं तदभाव उष्णत्वं स्पर्शनप्रत्यक्षेण गृह्यत इति बाधितत्वम्। व्याख्यातमनुमानम्॥

*yasya sādhyābhāvaḥ pramāṇāntareṇa niścitaḥ sa bādhitāḥ. yathā vahnirānuṣṇo dravyatvāditi. atrānuṣṇatvaṁ sādhyam*

*tadabhāva uṣṇatvaṃ sparśanapratyakṣeṇa grhyata iti bādhitatvam. vyākhyātamanumānam.*

**Translation: 50**

The contradicted ground is that which leads to the establishment of absence of probandum through some other process of knowing. For example, if someone says that fire is not hot because it is an entity, here, “not hot” is the probandum and its absence will be “hot” which can be verified by our sense organ of touch. This explains the process of inference.

**Notes: 50**

The contradiction is proved by another process of knowing. If one claims that fire is cold, on some ground, its opposite is proved by perception.

**Text: 51**

उपमितिकरणम् उपमानम्। संज्ञासंज्ञिसम्बन्धज्ञानम् उपमितिः। तत्करणं सादृश्यज्ञानम्। तथाहि कश्चिद् गवयशब्दार्थमजानन् कुतश्चिदारण्यक-पुरुषाद् गोसदृशो गवय इति श्रुत्वा वनं गतो वाक्यार्थं स्मरन् गोसदृश-पिण्डं पश्यति। तदनन्तरमसौ गवयशब्दवाच्य इत्युपमितिरुत्पद्यते। व्याख्यातमुपमानम्॥

*upamitikaraṇamupamānam. saṃjñāsajñīsambandhajñānamupamitiḥ. tatkaranaṃ sādṛśyajñānam. tathāhi kaścid gavayaśabdārthamajānan kutaścid āraṇyakapuruṣāt gosadṛśo gavaya iti śrutvā vanaṃ gato vākyaṛtham smaran gosadṛśapiṇḍaṃ paśyati. tadanantaramasau gavayaśabdavācya ityupamitirutpadyate. vyākhyātamupamānam.*

**Translation: 51**

Upamāna or analogical process is that through which an analogical cognition is produced. An analogical cognition is a cognition of the relationship between a name and the named. i.e. word and its meaning. The instrument of that is the knowledge of similarity.

To explain, suppose someone does not know the meaning of the word gavaya and goes to the forest and asks the forester the meaning of it, the forester says that gavaya is similar to cow. Having heard this, he again goes to the forest and sees an animal similar to cow and immediately remembers the sentence of the forester. After that, an analogical cognition arises such as this (animal) is the referent of the word gavaya. This is how the process of upamāna is explained.

**Notes: 51**

Naiyāyikas need this process to know the relationship between a word and its meaning which is not known by any other process. Udayana mentions upamāna as a means of knowing the samjñā-samjñi-sambandha in the following verse:

*śakti-graho vyākaraṇopamāna-  
kośāptavākyād vyavahārataśca,  
vākyasya-śeṣād vivṛtervadanti  
sānnidhyataḥ siddha-padasya vṛddhāḥ.*<sup>1</sup>

---

<sup>1</sup> Kīraṇāvalī

**Text: 52**

आप्तवाक्यं शब्दः। आप्तस्तु यथार्थवक्ता। वाक्यं तु पदसमूहः। यथा गाम्  
आनयेति॥

*āptavākyaṃ śabdaḥ. āptastu yathārthavaktā. vākyaṃ tu  
padasamūhaḥ. yathā gāmānayeṭi.*

**Translation: 52**

*Śabda (source of our verbal understanding) is a sentence  
of a reliable person. A reliable person is one who speaks  
the truth or fact.*

*A sentence is defined as: 'a collection of words or  
morphemes'.*

**Notes: 52**

Śabda does not mean 'word' here. It stands for sentence of  
a reliable person who wants to share his or her knowledge.  
One who knows the fact and wants to share the knowledge  
of the fact is an āpta.

Sentence also is defined semantically. That linguistic  
string of morphemes which satisfies three conditions  
namely, mutual expectancy, compatibility and proximity,  
which are going to be discussed in Text No. 54.

There are two traditions of defining: defining formally  
and defining semantically.

The Pāṇinian tradition defines formally and Nyāya  
tradition defines semantically. According to the tradition  
of Pāṇini a sentence is that expression unit which contains  
one finite verbal form (ekatiṅ vākyaṃ- Kātyāyana).

**Text: 53**

शक्तं पदम्। अस्मात्पदादयमर्थो बोद्धव्य इतीश्वरेच्छासङ्केतः शक्तिः॥

*śaktam padam. asmātpadādayamartho boddhavya itiśvarecchāsanketaḥ śaktiḥ.*

**Translation: 53**

*A morpheme is a minimum meaningful unit of a language i.e. it has a relationship with its referent. The relationship is the desire of God which has the form "Let this meaning be understood from this morpheme."*

**Notes: 53**

Pada means a minimum meaningful unit of a sentence i.e. a morpheme if we talk in terms of modern linguistics.

Pāṇini defines pada as a finished form (subanta or tiñanta) which is a formal definition.

But Naiyāyikas define pada semantically as 'that which is related to its meaning (śakta)'. Śakta means 'that which possesses śakti'. Śakti means a primary relationship between a morpheme and its referent. Vṛtti is the term which refers to both, the primary relationship (śakti) and the secondary or extended relationship called lakṣaṇa.

According to this system the creator of universe and the language is God. Hence His desire stands for the primary relationship initially. But in course of time the term śakti meant any 'desire' giving room for coinage of words by human beings also. All technical terms, proper names etc. get explained in this way.



### **Text: 54**

आकाङ्क्षा योग्यता सन्निधिश्च वाक्यार्थज्ञानहेतुः। पदस्य पदान्तरव्यतिरेकप्रयुक्तान्वयाननुभावकत्वमाकाङ्क्षा। अर्थाबाधो योग्यता। पदानामविलम्बेनोच्चारणं सन्निधिः। आकाङ्क्षादिरहितं वाक्यमप्रमाणम्। यथा गौरश्वः पुरुषो हस्तीति न प्रमाणमाकाङ्क्षाविरहात्। अग्निना सिञ्चतीति न प्रमाणं योग्यताविरहात्। प्रहरे प्रहरे असहोच्चारितानि गामानयेत्यादिपदानि न प्रमाणं सान्निध्याभावात्॥

*ākāṅkṣā yogyatā sannidhiśca vāk्यārthajñānahetuḥ. pada-sya padāntaravyatirekaprayuktānvayānanubhāvakatvamākā-  
ṅkṣā. arthābādho yogyatā. padānāmavilambenoccāraṇam  
sannidhiḥ. ākāṅkṣādirahitaṁ vāk्यamapramāṇam. yathā  
gaurāśvaḥ puruṣo hastīti na pramāṇam ākāṅkṣāviraḥāt.  
agninā siñcatīti na pramāṇam yogyatāviraḥāt. prahare  
prahare 'sahocāritāni gāmānayetiyādipadāni na pramāṇam  
sānnidhyābhāvāt.*

### **Translation: 54**

The causes of verbal understanding are mutual expectancy, compatability and proximity. The expectancy is the state of not generating, by one morpheme, the understanding of relationship prompted by the absence of another morpheme. The compatability means absurdity of relating two meanings. Proximity means utterance of morphemes one after the other without a gap more than necessary. A sentence which does not have these factors like expectancy etc. is not a valid sentence. For instance, the collection of words like cow, horse, man, elephant, is not a valid sentence because these morphemes do not

have any mutual expectancy. The sentence “one sprinkles fire” is also not a valid sentence because it does not have compatibility. If someone utters a sentence like “bring a cow” the first word in the morning and the second one in the afternoon, such a sentence will not be a valid sentence, because there is no proximity here.

**Notes: 54**

Human beings speak language. When he or she speaks, he or she performs a speech act. Every speech act of a normal human being is intentional. Therefore, when he or she speaks, he or she sends an invitation to the listener or the reader to visit the world of the speaker.

A sentence is an encoded cognition of his or her world. The hearer or reader is expected to decode that sentence and visit the world of the speaker which formed the object of the knowledge of the speaker which he or she encoded. When this happens we say that there is rapport (saṁvāda) between the speaker and the listener and when this does not happen we say that there is failure of communication (visaṁvāda). Keeping this situation of use of language in view, the Naiyāyikas have defined the semantic concepts such as ākāṅkṣā, yogyatā and sannidhi. In the absence of any of these factors, a sentence fails to be the medium of successful communication.

**Text: 55**

वाक्यं द्विविधम्। वैदिकं लौकिकञ्च। वैदिकमीश्वरोक्तत्वात्सर्वमेव प्रमाणम्।  
लौकिकन्तु आप्तवाक्यं प्रमाणम्। अन्यदप्रमाणम्॥

*vākyaṃ dvividhaṃ. vaidikaṃ laukikañca. vaidikamīśvaro-  
ktatvātsarvameva pramāṇam. laukikantu āptavākyaṃ  
pramāṇam. anyadapramāṇam.*

**Translation: 55**

*A sentence is of two types, a Vedic sentence and an ordinary sentence. All the Vedic sentences are valid source of verbal understanding because they are uttered by God. But, only that ordinary sentence which is uttered by a reliable person can be treated as a valid source of verbal understanding. Other sentences are not valid.*

**Notes: 55**

Language is classified into two categories: language of scripture like the language of the Vedas and ordinary language that we speak. The first category involves faith in a culture and the second category is any language that human beings speak. Faith and respect in a culture prompts its defense and urge for its continuity. To add rationality to it requires broader generalization. Exactly this is what has happened here. It is absolutely rational to say that a sentence is dependable if and only if it is a sentence of a reliable person, and not a sentence of a cheat or of one who wants to mislead. An ordinary sentence of an ordinary human being is possible to be of both the types: reliable and non-reliable. But how can such possibility be allowed about a sentence which is culturally respected? That is why, a speaker like God who knows the truth and is compassionate to share the truth and is kind enough to show the right path of self-realization to humanity is

brought into the frame-work of rationality. Vedic culture is valuable and hence it must continue. But basically, the Vedic culture was a text-bound culture.

Therefore, unless the authenticity is attributed to the Vedic text, how can this culture maintain its continuity? It is this reason that prompted the Nyāya system to ascribe authenticity to the Vedic texts by saying that the Vedas are uttered by God. Since by definition God is all-knowing and all-compassionate and since such a God created the Vedic texts, Vedas must be treated as authentic.

The sentence of the human beings, however, can be both, authentic and non-authentic. But only those sentences are authentic and dependable which are the sentences of a trust-worthy person.

### ***Text: 56***

वाक्यार्थज्ञानं शाब्दज्ञानम्। तत्करणं शब्दः॥

*vākyaṛthajñānam śābdajñānam. tatkaṛaṇam śabdaḥ.*

### ***Translation: 56***

*The understanding that is caused by the knowledge of the sentence meaning is called verbal understanding. The instrument of such a cognition is called śabda or a sentence.*

### ***Notes: 56***

The understanding which arises from an authentic sentence is called verbal understanding and such a sentence is called verbal testimony (śabda-pramāṇa). In other words, an authentic sentence encodes a true cognition and

an unauthentic sentence encodes a false cognition. That is why, after decoding the authentic sentence one arrives at the valid understanding and after decoding the inauthentic sentence one arrives at an invalid or false understanding.

**Text: 57**

इति यथार्थानुभवो निरूपितः॥

*iti yathārthānubhavo nirūpitah.*

**Translation: 57**

*This is how a true experience is described.*

**Notes: 57**

Thus, the entire world can be known by four ways of knowing (pramāṇa), namely, the direct process of internalizing, the process of inferring, the peculiar process of knowing the word-meaning-relationship and the process of verbal understanding, and the results of these four processes of knowing are perceptual, inferential, analogical, and verbal cognition or understanding.

**Text: 58**

अथार्थानुभवस्त्रिविधः संशयविपर्ययतर्कभेदात्। एकस्मिन्धर्मिणि विरुद्ध-  
नानाधर्मवैशिष्ट्यावगाहिज्ञानं संशयः। यथा स्थाणुर्वा पुरुषो वेति। मिथ्या-  
ज्ञानं विपर्ययः। यथा शुक्ताविदं रजतमिति। व्याप्यारोपेण व्यापकारोपः  
तर्कः। यथा यदि वह्निर्न स्यात्तर्हि धूमोऽपि न स्यादिति॥

*ayathārthānubhavastrividhaḥ saṁśayaviparyayatarkabhedāt.  
ekasmindharmiṇi viruddha-nānādharma-vaiśiṣṭyāvagāhijñā-  
nam saṁśayah. yathā sthāṇurvā puruṣo veti. mithyājñā-*

*nam viparyayaḥ. yathā śuktau idaṁ rajatam iti. vyāpyā-  
ropeṇa vyāpakāropastarkaḥ. yathā yadi vahnirna syāttarhi  
dhūmo'pi na syāditi.*

**Translation: 58**

A false cognition is of three types: (i) doubt (ii) error and (iii) hypothetical assumption. A doubt is that cognition which reflects mutually contradicted properties residing in one locus. E.g. the doubt whether it is a post or it is a man. An erroneous cognition is a false cognition. For instance, when looking at a conch shell someone says 'this is silver'. An hypothetical assumption is that in which one assumes or imagines a pervader by assuming or imagining the pervaded. For example, when someone says: 'had there not been fire there would not have been smoke'.

**Notes: 58**

Doubt, erroneous cognition and cognition of imagined or constructed world are the three types of false cognitions. When two contradictory properties appear to share one and the same locus, it becomes a case of doubt:

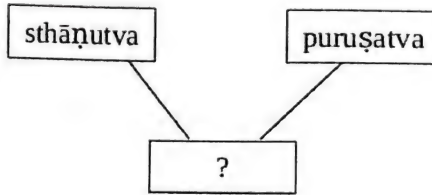

= Doubt whether it is a post or a man.

When the property is seen occurring in a locus whereas in fact, there is absence of that property it becomes a

case of error or mistake. It does not happen willfully, it simply happens due to a number of factors (either in the object of perception, or distance, or defects in the senses, or disturbance in the mind and so on):

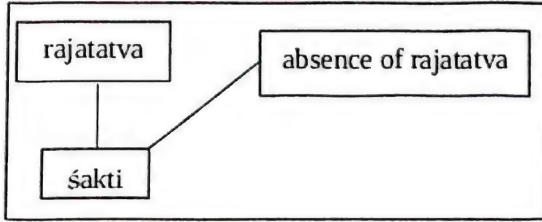

(This is silver): Error

In the third type of false cognition the cognizer knows that he has imagined an event or situation, which is not present outside at that moment of time. This is an imagination of a possibility, of course, which matches the fact, experienced before. This is not absurd, but this can be verified. That is why, it can be used to confirm the invariable relationship of the probans (hetu) with the probandum (sādhyā). This is why, tarka has been counted in the list of false cognitions.

### ***Text: 59***

स्मृतिरपि द्विविधा। यथार्था अयथार्था च। प्रमाजन्या यथार्था। अप्रमाजन्या अयथार्था॥

*smṛtirapi dvividhā. yathārthā'yathārthā ca. pramājanyā yathārthā. apramājanyā ayathārthā.*

**Translation: 59**

A remembrance is also of two types: (i) true and (ii) false. A true remembrance is that which is caused by true cognition. A false remembrance is that which is caused by false cognition.

**Notes: 59**

As experience can be of two types: true or false, so also remembrance can be true or false. A true remembrance is produced by the impressions provided by true experience and a false remembrance is produced by the impressions produced by false impressions.

**Text: 60**

सर्वेषामनुकूलतया वेदनीयं सुखम्॥

*sarveṣāmanukūlatayā vedanīyaṁ sukham.*

**Translation: 60**

Happiness is that quality of the self which everybody wants to have.

**Notes: 60**

The feeling, a human being wants to have again and again, is pleasure. The knowledge or experience of something produces pleasure. Knowledge itself is not pleasure, as the Buddhists think. We have knowledge of pleasure and so knowledge is different from pleasure. We also have desire of pleasure and therefore desire is not pleasure. Pleasure is always a product and hence it can never be permanent.



That is why; external pleasure is not postulated as the parama-puruṣārtha by the Nyāya-Vaiśeṣika philosophers. According to them, absolute 'cessation of pain' is the ultimate goal of human life. Since existence of permanent pleasure is not possible, it cannot be postulated as the ultimate goal. The cause of sukha is also called pleasure secondarily, as ghee which is the source of healthy life is also called 'life' (āyurvai ghṛtam).

***Text: 61***

प्रतिकूलतया वेदनीयं दुःखम्॥

*pratikūlatayā vedanīyam duḥkham.*

***Translation: 61***

*Unhappiness is that which nobody wants.*

***Notes: 61***

What one and all normal human beings do not want to have is the feeling of pain. Nobody wants pain. It is not the case that one does not want pain for only some time, rather he or she does not want pain for ever. But the fact is this that every pleasure is terminated in pain, because the pleasure is momentary. Wherever there is pleasure, there is pain. It is true that human beings want pleasurable feeling, but since it is not possible to be in that state always, and since every pleasurable state is converted into pain, the Nyāya-Vaiśeṣika philosophers argued in favor of 'absolute cessation of pain' as the ultimate goal of life.

The source of duḥkha is also called pain secondarily.

**Text: 62**

इच्छा कामः॥

*icchā kāmaḥ.*

**Translation: 62**

*Desire is kāma.*

**Notes: 62**

Desire is want. Obviously, what is known can only be desired. Thus, the desire is preceded by knowledge. Knowledge presents x before us and if we are in need of it we want to have x.

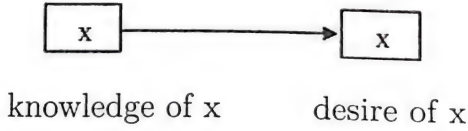

Thus, knowledge produces 'desire'.

**Text: 63**

क्रोधो द्वेषः॥

*krodho dveṣaḥ.*

**Translation: 63**

*Hatred is anger.*

**Notes: 63**

Aversion means 'anger'. When a desire remains unfulfilled, it results into anger.

**Text: 64**

कृतिः प्रयत्नः॥

*kṛtiḥ prayatnaḥ.*

**Translation: 64**

*Volition is internal effort.*

**Notes: 64**

Volition means mental preparedness. After knowledge presents x, there arises the desire of x and thereafter there occurs mental preparation to take up an external activity (ceṣṭā) to obtain x.

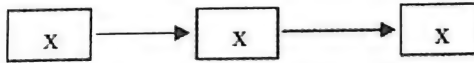

knowledge  
of x

desire  
of x

volition  
of x

It should be noted that the object of knowledge is the object of desire and also of volition. It cannot be the case that x is known and y is desired and the mental readiness arises with regard to z.

All these three are mental states. What is visible after the volition is called ceṣṭā or external physical activity.

**Text: 65**

विहितकर्मजन्यो धर्मः॥

*vihitakarmajanyo dharmah.*

**Translation: 65**

*Dharma is that which is produced by sanctioned act.*

**Notes: 65**

Dharma stands for the result of a moral act or duty. It is the merit left behind by an act which is sanctioned by the society or social history, which includes Vedic injunctions, which aim at bestowing human good.

It is the result of a moral act in the sense that it is an outcome of an act of duty. In terms of this dharma next birth is explained. It is also called puṇya (merit).

**Text: 66**

निषिद्धकर्मजन्यस्त्वधर्मः॥

*niṣiddhakarmajanyastvadharmaḥ.*

**Translation: 66**

*Adharma is that which is produced by a prohibited act.*

**Notes: 66**

Adharma is opposite of dharma (demerit). A bad act produces adharma which is held responsible for miserable life after death. It is also called pāpa.

The cycle of birth and death is explained in terms dharma and adharma. Both are collectively called adṛṣṭa. It is postulated as a causal link (apūrva) between the performance of an act and the result that a good or bad act is expected to produce.

**Text: 67**

बुद्ध्ययादयोऽष्टावात्ममात्रगुणाः। बुद्धीच्छाप्रयत्ना द्विविधाः नित्या अनित्याः  
च। नित्या ईश्वरस्य। अनित्या जीवस्य॥

*buddhyādayo 'ṣṭāvātma-mātra-guṇāḥ. buddhīcchā-prayatnā  
dvividhā nityā anityāḥ ca. nityā īśvarasya. anityā jīvasya.*

**Translation: 67**

*There are eight special qualities beginning from cognition which are situated only in the Self. Cognition, desire and volition can be eternal and non-eternal. They are eternal in God and non-eternal in an individual Self.*

**Notes: 67**

Individual's inner world consists of knowledge, pleasure, pain, desire, aversion, volition, merit, demerit and impressions. These are the qualities of the spiritual substance, called self. These do not reside in any other substance. These are special qualities of the self. All human beings are given with this inner world. My inner world is different from your inner world in the sense that I alone can be aware of my inner world and not the inner world of others. I can, however, infer others' inner worlds. Others' inner worlds are external to me, and similarly, my inner world is external to others. Knowledge, desire and volition of God have to be eternal, otherwise the creation cannot be explained rationally. If this knowledge etc. also are treated as non-eternal, He will not be different from any human being and in that case He cannot create the universe.

**Text: 68**

संस्कारस्त्रिविधः। वेगो भावना स्थितिस्थापकश्च। वेगः पृथिव्यादिचतु-  
ष्टयमनोवृत्तिः। अनुभवजन्या स्मृतिहेतुर्भावना आत्ममात्रवृत्तिः। अन्यथा-  
कृतस्य पुनस्तदवस्थापादकः स्थितिस्थापकः। कटादिपृथिवीवृत्तिः॥

*saṁskārastrividhaḥ. vego bhāvanā sthitisthāpakaśca. vegaḥ  
pṛthivyādicatuṣṭayamanovṛttiḥ. anubhavajanya smṛtihatūr-  
bhāvanā. ātmamātravṛttiḥ. anyathākṛtasya punastadava-  
sthāpādakaḥ sthitisthāpakaḥ. kaṭādipṛthivīvṛttiḥ.*

**Translation: 68**

Impression is of three kinds: (i) velocity, (ii) impressions left behind by experience and (iii) elasticity. Velocity is found in five substances viz. earth, water, fire, air and mind. Impression produced by experience is the cause of remembrance. It exists only in the self. Elasticity is that quality which brings back a substance to its original form when that substance assumes another form. It is found only in materials like mat etc. made of earth.

**Notes: 68**

The first non-material cause of the first moment of falling of a fruit from the tree is weight (gravity) and the non-material cause of the second moment of falling onwards is the velocity.

Remembrance is caused by impressions alone which are produced by experiences. These impressions also exist only in the self and hence they are the members of our inner world. Elasticity is the peculiar quality of the earth only.

**Text: 69**

चलनात्मकं कर्म। ऊर्ध्वदेशसंयोगहेतुरुत्क्षेपणम्। अधोदेशसंयोगहेतुरप-  
क्षेपणम्। सन्निकृष्टसंयोगहेतुराकुञ्चनम्। विप्रकृष्टसंयोगहेतुः प्रसारणम्।  
अन्यत्सर्वं गमनम्। पृथिव्यादिचतुष्टयमनोमात्रवृत्तिः॥

*calanātmakam karma. ūrdhvadeśasamyogaheturutkṣepaṇam. adhodeśasamyogaheturapakṣepaṇam. sannikṛṣṭasamyogahe-  
turākūñcanam. viprakṛṣṭasamyogahetuḥ prasāraṇam. anya-  
tsarvam gamanam. pṛthivyādicatuṣṭayamanovṛtti.*

**Translation: 69**

Action is any movement. The action of throwing up is the cause of the contact of the substance with the upper region. Throwing down is the cause of contact with the lower region. The action of shrinking is the cause of contact with the region nearer one's body. The action of spreading is the cause of contact with the region away from the body. All other actions are mere movement.

**Notes: 69**

As a matter of fact action is movement of any type. Five varieties are stated only to illustrate this aspect.

**Text: 70**

नित्यमेकमनेकानुगतं सामान्यम्। द्रव्यगुणकर्मवृत्तिः तद्विधं परापर-  
भेदात्। परं सत्ता। अपरं द्रव्यत्वादि॥

*nityamekamanekānugataṁ sāmānyam. dravyaguṇakarmavṛtti. tadvividhaṁ parāparabhedāt. param sattā. aparam  
dravyatvādi.*

**Translation: 70**

Universal is one, eternal and present in all particulars. That is of two kinds: *para* (highest universal) and *apara* (lower universal). Highest universal is being (*sattā*). The lower universals are substanceness etc.

**Notes: 70**

Universal is a class-forming property. Through this the members of a class is brought under one group. By 'potness' all pots are brought under one class.

The universal is one and through this the individuals are named by a single name. Thus, through potness (i.e. the ground for the application of the term 'pot') all pots are called by one and the same name. A particular shape (*ākṛti*) reveals a particular universal (*jāti*).

Depending on the area it occupies, a universal can be *para* or *apara*. *Para* means wider and *apara* means smaller in area of existence. It can be illustrated as follows:

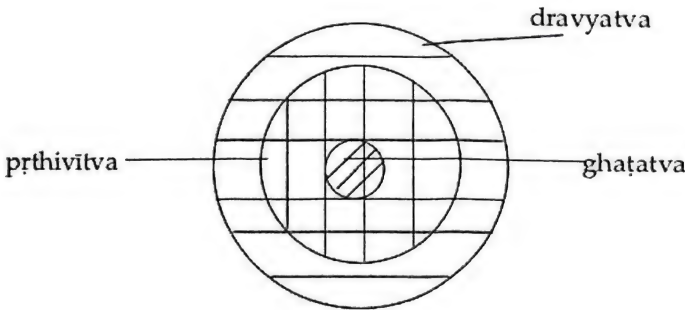

In a pot all the three are present:



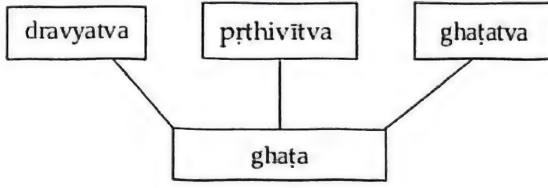

But these three properties or universals are related by the relationship of pervader and pervaded. Dravyatva is pervader of the other two, but is not pervaded by any of the other two. But pṛthivīva is pervader of ghaṭatva and is pervaded by dravyatva. Similarly, ghaṭatva is only pervaded by the other two and is not pervader of the either of the two. This is how they are related.

***Text: 71***

नित्यद्रव्यवृत्तयो व्यावर्त्तका विशेषाः॥

*nityadravyavṛttayo vyāvartakā viśeṣāḥ.*

***Translation: 71***

*Particulars (viśeṣa) are existent in permanent substances and they distinguish each one from the other.*

***Notes: 71***

The discreteness of all permanent substances is obtained by introducing this concept of viśeṣa. All the atomic states of earth, water, fire and air, sky, time, space, all individual souls, and mind are distinct from one another on account of the viśeṣa. There are so many viśeṣas as many permanent substances. The viśeṣa-s, however, are distinct by themselves.

**Text: 72**

नित्यसम्बन्धः समवायः। अयुतसिद्धवृत्तिः। ययोर्द्वयोर्मध्ये एकमविनश्यद्  
अपराश्रितमेवावतिष्ठते तावायुतसिद्धौ। यथा अवयवावयविनौ गुणगुणिनौ  
क्रियाक्रियावन्तौ जातिव्यक्ती विशेषनित्यद्रव्ये चेति॥

*nityasambandhaḥ samavāyah. ayutasiddhavṛttiḥ. yayor-  
dvayormadhye ekamavinaśyad aparāśritamevāvatiṣṭhate  
tāvāyutasiddhau. yathā avayavāvayavinau guṇaguṇināu  
kriyā- kriyāvantaū jātivyaktī viśeṣanityadravye ceti.*

**Translation: 72**

*Inherence is a permanent relationship. It is found in two  
inseparable entities. Two entities are said to be inseparable  
when one depends on the other unless one of them is  
destroyed.*

*For example, there is inherence between a part and a  
whole, between quality and substance, between action and  
substance, between universal and particular and between  
particular (viśeṣa) and permanent substance.*

**Notes: 72**

Relation as an entity or objective reality is accepted in  
this system on the basis of qualified knowledge. A qualified  
knowledge is caused by this entity.

Without a relationship there cannot arise any qualified  
knowledge (viśiṣṭa-jñāna). Every qualified cognition,  
therefore, reflects three things in a structured form: (a)  
qualifier (viśeṣaṇa), relation (sambanda) and qualificand  
(viśeṣya):

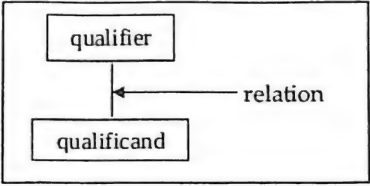

qualified cognition

Such a relation can be separable or inseparable. Separable relation is contact or conjunction (sam̄yoga) and inseparable (samavāya). There are five such cases where inseparable relationship is accepted:

(1)

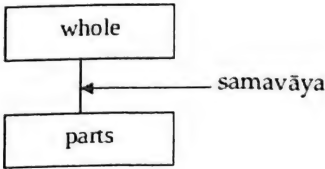

(2)

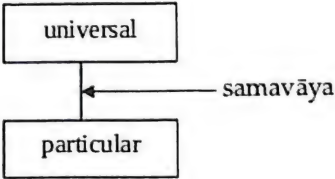

(3)

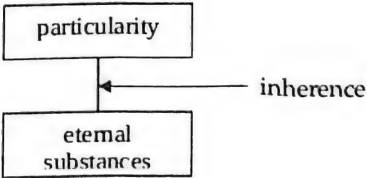

(4)

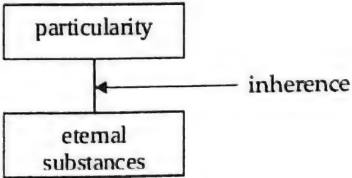

(5)

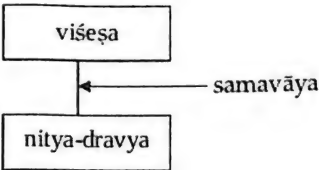

Examples for

(1)

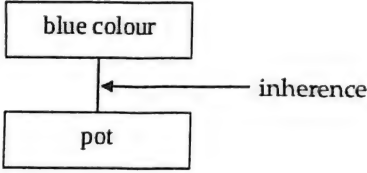

(2)

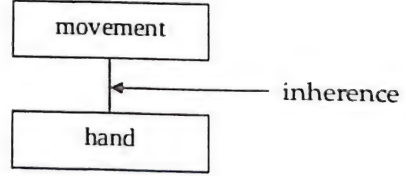

(3)

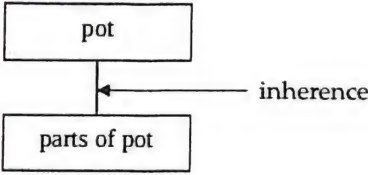

(4)

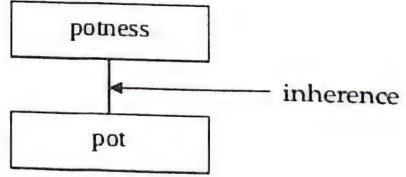

(5)

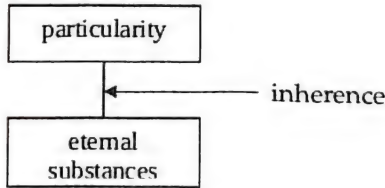

**Text: 73**

अनादिः सान्तः प्रागभावः। उत्पत्तेः पूर्वं कार्यस्य॥

*anādiḥ sāntaḥ prāgabhāvaḥ. utpatteḥ pūrvam kār̥yasya.*

**Translation: 73**

*Pre-absence has no beginning but an end. For instance, there is pre-absence of an effect before it comes into being.*

**Notes: 73**

The pre-absence of an effect exists in the materials out of which the effect is going to be produced and it comes to an end after the effect comes into being. It has no beginning but has an end. The pre-absence is considered to be a cause of the effect.

The system of Nyāya-Vaiśeṣika does not accept satkāryavāda, according to which the effect is accepted to be present in its cause. Instead, there is pre-absence of the effect in the cause—hold the Naiyāyikas. This is the reason that they define an effect (kārya) as the counter positive of a pre-absence. For the satkāryavādins utpatti means abhivyakti (manifestation), whereas for the ārambhavādins (i.e. the Naiyāyikas), utpatti means ‘coming into being which was not there.’

**Text: 74**

सादिरनन्तः प्रध्वंसः। उत्पत्त्यनन्तरं कार्यस्य॥

*sādiranantaḥ pradhvaṁsaḥ. utpattyanantaram kāryasya.*

**Translation: 74**

*Destruction has a beginning but no end. For example, when an effect gets destroyed after it comes into being.*

**Notes: 74**

There are three states: (a) the pre-absence of an effect (say, pot) in its cause (i.e. kapālas), (b) then the effect (pot) comes into being and (c) when the pot gets destroyed the destruction of the effect (pot) comes into being. The

destruction has beginning but has no end. Whatever is a product is likely to be destroyed. This generalization is valid for positive entities only. Because, the destruction has a beginning i.e. it is produced, but has no end. Pre-absence has no beginning but it comes to an end.

**Text: 75**

त्रैकालिकसंसर्गावच्छिन्नप्रतियोगिताकोऽत्यन्ताभावः। यथा भूतले घटो नास्तीति॥

*traikālikasamsargāvacchinnapratiyogitāko 'tyantābhāvaḥ.  
yathā bhūtale ghaṭo nāstīti.*

**Translation: 75**

*An absolute absence is a relational absence in all the three times, past, present and future. For example, when we say there is no pot on the ground.*

**Notes: 75**

In this universe x exists in x by the relation of identity (tādātmya or abheda) and can exist elsewhere by the relation of difference (bheda). The relations of difference may be contact, inherence and self-linking (svarūpa). A pot exists on the ground by contact relation:

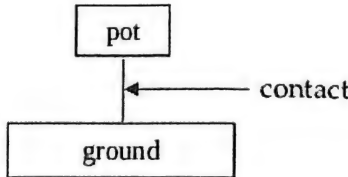

But pot exists in its parts by the relation of inherence:

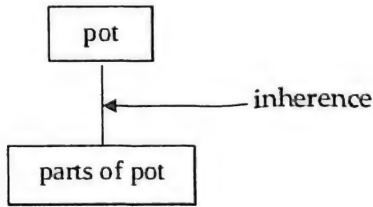

An absence of pot exists on the ground by the self-linking relation:

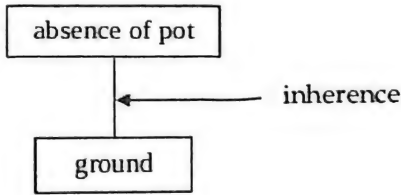

Because of the above fact, a pot does not exist on any ground by inherence. Not only that, pot does not exist on the same ground, where it exists by contact, by the relation of inherence.

Such absences are called absolute absence.

The term absolute absence does not refer to absence of sky-flower because sky-flower does not exist anywhere at all. Absence of only that is possible, which exists somewhere by some relationship.

Therefore, the sentence 'There is no sky-flower' is an empty sentence according to this system.

The absence of pot on the ground by contact is a fact which is true at all times, past, present and future. As a matter of fact, it also exists in the place where pot exists.

But its presence does not allow its knowledge to occur because its counter-positive is present there.

Some philosophers like the Prābhākaras think that the absence of pot on ground is produced when the pot is removed from that ground and when the pot is brought back to that ground that absence gets destroyed. But this theory is not acceptable to the Nyāya-Vaiśeṣikas.

The reference 'there is no pot on this ground by contact' is valid in all the three times, present, past, and future.

As a matter of fact, this absence refers to an absence of the denial of the relation of difference (bheda- sambandha).

### ***Text: 76***

तादात्म्यसम्बन्धावच्छिन्नप्रतियोगिताकोऽन्योन्याभावः। यथा घटः पटो न भवतीति॥

*tādātmyasambandhāvacchinnapratiyogitāko 'nyonyābhāvaḥ.  
yathā ghaṭaḥ paṭo na bhavatīti.*

### ***Translation: 76***

*A mutual absence is that absence which describes the counter-positiveness which is delimited by the relation of identity. For example, the pot is not cloth.*

### ***Notes: 76***

Because x is identical with x and different from all that is not x, we say 'x is not y'. It means 'x is identical with x', 'y is identical with y' and so 'x is not y'. This is a case of denial of the relation of identity.



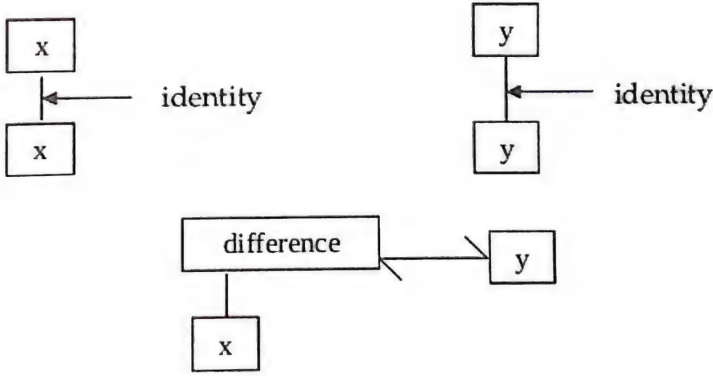

**Text: 77**

सर्वेषामपि पदार्थानां यथायथमुक्तेष्वेवान्तर्भावत्सप्तैव पदार्था इति सिद्धम्॥  
*sarveṣāmapi padārthānām yathāyathamukteṣvevāntarbhāvāt  
saptaiva padārthā iti siddham.*

**Translation: 77**

Since all entities (referents) can be included in the list of seven stated in the beginning, there are only seven types of entities which constitute the whole of our universe. This is how it has been established.

**Notes: 77**

Gautama Nyāyasūtra 1.1.1 mentions sixteen padārthas namely: process of knowing (pramāṇa), object of knowledge (prameya), doubt (saṁśaya), purpose (prayojana), example (dṛṣṭānta), doctrine (siddhānta), member of syllogistic argument (avayava), imagined fact (tarka), conclusion (nirṇaya), discourse to arrive at the truth (vāda), disputation (jalpa), negative attitude of

finding fault with a view without providing an alternative solution (vitaṇḍa), bad ground for inference (hetvābhāsa), twisting argument (cala), wrong answer (jāti) and points or ground for defeat (nigrahasthāna).

These padārthas are directly or indirectly helping factors in the process of inference. However, all of them are entities and therefore, these can be included in the already accepted seven sets of entities forwarded by the Nyāya-Vaiśeṣika system.

Thus, categorically the whole universe is put into seven categories of entities is an adequate and exhaustive classification.

**Text: 78**

काणादन्यायमतयोर्बालव्युत्पत्तिसिद्धये।

अन्नम्भट्टेन विदुषा रचितस्तर्कसंग्रहः॥

इति तर्कसङ्ग्रहः समाप्तः॥

*kāṇādanyāyamata yorbālavvyutpattisiddhaye,*

*annambhaṭṭena viduṣā racitastarkasaṅgrahaḥ.*

*iti tarkasaṅgrahaḥ samāptaḥ.*

**Translation: 78**

The learned scholar, Annambhaṭṭa, has composed this text called *Tarkasaṅgraha* in order to facilitate the understanding of the learners about the doctrines of Kāṇāda i.e. Vaiśeṣika) and Nyāya. Here ends the text *Tarkasaṅgraha*.

*Notes: 78*

This small introductory handbook of Nyāya-Vaiśeṣika philosophy is a profound text through which one can easily enter into not only the Nyāya-Vaiśeṣika system of thought but also into Indian intellectual and analytical traditions.



## Key Terms

abhāsvara	non-radiant
abhāva	absence
abhāva-padārtha	negative entity
abhidheya	nameable
abhidheyatva	nameability
abhinna	not different i.e. identical
adharma	demerit
adhikaraṇa	locus
agni	fire/heat/light
anaikāntika	inconsistent
ananta	innumerable
ananyathāsiddha	not redundant
anavasthā	endless regress
anādi	without a beginning
anekānugata	consequitively present in many
anitya	impermanent/non-eternal
anuṣṇa	not hot
anuṣṇāśīta	not hot, not cold
anubhava	experience
anumāna	inference
anumiti	inferential cognition
anupasaṃhārin	inconclusive
anyonyābhāva	mutual absence
ap	water
apakṣepaṇa	throwing down
asamavāyin	non-material
asambhava	non-application
asādhāraṇa	inconsistent in a unique way
asiddha	unestablished/unknown

asurabhi	foul
ativyāpti	over-application
atyanta-abhāva	absolute absence
avacchedaka	delimiter
avacchinna	delimited
avayava	member of syllogistic argument
avyāpti	narrow-application
ayathārtha	false cognition
ayutasiddha	not found unrelated
āditya-loka	world of sun
āgantuka-dharma	contextual property
ākuñcana	contracting
ākāñkṣā	expectancy
ākāśa	sky/ether
āmla	sour
āśrayāsiddha	whose locus is not known
ātma	soul
bādhita	contradicted
bhauma	earthly
bhāsvara	radiant
bhāva-padārtha	positive entity
bhāvanā	impression
bherī	drum
bhinna	distinct
bhrama	error/erroneous cognition
buddhi	cognition
cala	twisting argument
citra	mixed colour
cakṣu	eye
cetana	conscious

cūrṇa	powder
daṇḍa	stick
dharma	property/merit
dhūma	smoke
diś	space
dravatva	fluidity/liquidity
dravya	substance
dr̥ṣṭānta	example
duḥkha	pain/unhappiness
dveṣa	aversion
gamana	moving
gandha	smell/odor
ghrāṇagrāhya	revealed by nose
guṇa	quality
gurutva	gravity/weight/heaviness
harita	green
hetvābhāsa	fallacious ground or bad ground for inference
hrasva	of middle size
icchā	desire
indriya	sense-organ
īśvara	God
jīvātman	individual Self
jñāna	cognition/knowledge
jñeya	knowable
kaniṣṭha	youngest
kapiśa	brown
karaṇa	instrument
karma	action
kaṣāya	astringent

kaṭu	hot
kāla	time
kārya	product
kāryarūpā	in the form of product
krodha	anger
kṛti	volition
lakṣya	the thing to be defined
lakṣaṇa	definition
liṅga	mark
liṅgaparāmarśa	confirmatory cognition
mahaddīrgha	big/long
manas	mind
mithyājñāna	false cognition
mṛd	earth
mukha	face
mūrta-dravya	substance having limited size
naimittika	incidental
nigamana	conclusion
nigrahasthāna	points of defeat
nirākāra	formless
nirṇaya	conclusion
nirvikalpaka-jñāna	indeterminate cognition
nirvikalpaka-pratyakṣa	indeterminate perception
niṣkramaṇa	going out
niṣprakāra	without the qualifier
nitya	permanent/eternal
nityadravyavṛtti	existing in permanent substances
nityasambandha	permanent relationship
padasamūha	a collection of words/morphemes
padārtha	entity/referent

pakṣa	subject
pakṣa-dharmatā	state of being in the subject
pañcāvayava-vākya	five membered syllogism
paramāṇu	particle/atom
paramātman	God
paratva	remoteness
parāmarśa	confirmatory cognition
parārtha	for convincing others
parārthānumāna	inference to convince others
parimāṇa	measure
parvata	mountain
paṭa	cloth
pācaka	cook
pīta	yellow
pradhvaṁsābhāva	destruction
prakāra	qualifier
pramā	true cognition
pramāṇa	process of knowing
prameya	object of knowledge
prasāraṇa	expanding
pratijñā	proposition
pratiyogin	counter-positive
praticī	east
pratyakṣa	perceptual cognition
prayatna	volition/internal effort
prayojana	purpose
prāṇa	breathing air (breath)
prāg-abhāva	pre-absence
pr̥thaktva	separateness
pr̥thivī	earth



rakta	red
rasa	taste
rasanā	tongue
rūpa	colour
śabda	sound
saṅketa	primary relation between word and its meaning
saṅkhyā	number
samaniyatatva	co-extensiveness
samaveta-dharma	inherent property
samavāya	inherence
samavāyi-kāraṇa	material cause
samāna	digestive fire in the stomach
sambandha	relation
saṁsargābhāva	relational absence
saṁskāra	impression
saṁśaya	doubt
saṁyoga	contact/conjunction
śarīra	body
śāśa-sṛṅga	rabbit's horn
sattā	existence
sarvadravyavṛtti	exists in all substances
sarvajña	all-knowing
savikalpaka-jñāna	determinate cognition
savikalpaka-pratyakṣa	determinate perception
savyabhicāra	bad ground which suffers from the defect of inconsistency
śābda-bodha	verbal understanding
sādhana	instrument/factor
sādhāraṇa	common

sādirananta	having a beginning and an end
sāhacaryaniyama	invariable concomitance
sāmsiddhika	natural
sāmsiddhika-dravatva	natural fluidity
sāmānya	universal
siddhānta	doctrine
smṛti	remembrance
sneha	moisture
sparsā	touch
śrotragrāhya	revealed by ears
śukla	white
śyāma	black
sukha	happiness (pleasure)
surabhi	fragrant
suvarṇa	gold
svarūpāsiddha	bad ground the nature of which is not known
svābhāvika-dharma	natural property
svānumitihetu	ground to infer for oneself
svārthānumāna	inference for convincing oneself
tantu	thread
tejas	light
uddeśa	listing of items to be discussed
upamāna	analogy
upamiti	analogical
upanaya	confirmatory sentence
utkṣepaṇa	throwing up
utpatti	origination/coming into being
vakṛ	speaker
varṇātmaka	made of linguistic sound

varuṇa-loka	world of Varuṇa
vāda	discourse to arrive at the truth
vākya	sentence
vāyu	air
vāyu-loka	world of Vāyu
vibhāga	disjunction
vihitakarmajanya	produced out of a sanctioned act
viruddha	opposite
viṣaya	object of knowledge
viśiṣṭa-jñāna	qualified cognition
viśeṣa	particular
viśeṣa-padārtha	ultimate distinguishing entity
viśeṣaṇa	qualification
viśeṣya	qualified
vyakti	particular individual
vyatireka-vyāpti	negative concomitance
vyāvahārika	transational
vyāpya	pervaded
vyāvartaka	distinguishing feature
yathārtha	true

## Bibliography

1. Altuchow. N, El Tarkasaṅgraha de Annambhaṭṭa (F) (Tr.), Universidad De la Republica, Montevideo, 1959.
2. Annambhaṭṭa (Au.), Tarkasaṅgrahadīpikā, Grantha Prakashaka Press, Bombay, 1863
3. Annambhaṭṭa, Tarkasaṅgraha with Vākyavṛttikā of Meruśāstri, Suvidyapakashan, Pune, 1873
4. Annambhaṭṭa, Tarkasaṅgraha, (comm.) Nyāyabodhinī, Nirukti, Padakṛtya, Dīpikāprakāśa, Vākyārthabodhinī and Bhāṣāpariccheda, Vavilla Ramashastrulu, Chennai- puri, 1939
5. Annambhaṭṭa, Tarkasaṅgrahamu, Telugu Andhrabāla-priyā (comm.), Bhāratīya tarkaśāstra paricayamu, Ed.by Vaṅgīpuraṃ Rāmānujācārya, 1991
6. Athalye Y.V. (Ed.), Tarkasaṅgraha with Dīpikā of Annambhaṭṭa and Nyāyabodhinī of Govardhana, Belvalkar S. K., Pune, Bombay Sanskrit Series-55, 1930 (2<sup>nd</sup> Ed. Rev.)
7. Athalye Y.V. and Bodas M.R. (Eds.), Tarkasaṅgraha of Annambhaṭṭa with the author's own Dīpikā and Govardhana's Nyāyabodhinī and English Tr. of Bodas M.R., Bhandarkar Oriental Research Institute, Pune, Bombay Sanskrit Series-LV, Bombay 1963 (2<sup>nd</sup> ed.).
8. Atreya B.L., Elements of Indian Logic, text with Hindi and English tr. of Tarkasaṅgraha of Annambhaṭṭa, Nalanda Publications, Bombay, 1948 (3<sup>rd</sup> Ed.)
9. Bhāskarodaya LaksmīNṛsimha, Mukunda Jha, Pāṇḍurang Jāvajī, 1933
10. Bhāskarodaya LaksmīNṛsimha, Mukunda Jha, Tukaram Javaji, 1903

11. Bakre M.G. (Ed.), Tarkasaṅgraha of Annambhaṭṭa with Nyāyabodhinī of Govardhana and Padakṛtya of Chandraja Singha, Bombay, 1907 (2<sup>nd</sup> Ed.)
12. Bakre M.G. (Ed.), Tarkasaṅgraha of Annam- bhaṭṭa with the commentary Tarkavilasini of Murali- dharasastri, Nirṇaya Sāgar Press, Bombay, 1914
13. Bakre M.G. (Ed.), Tarkasaṅgraha of Annambhaṭṭa, (comm.) Nyāyabodhinī and Padakṛtya, Revised by N.R. Acharya, Nirṇaya Sāgar Press, Bombay, 1939
14. Bapat V.V., (Tr.), Tarkasaṅgraha of Annambhaṭṭa, Vishnusastra Bap, Pune, 1925, (2<sup>nd</sup> Ed.)
15. Bhaṅḍāri, Madhava Shastri (Ed.), Tarkasaṅgraha of Annambhaṭṭa, (comm.) Bālabodhini by Nṛsimhadeva Sastri, Meharchand Lachmandas, Delhi, 1938
16. Bhargava D., (Tr.), Tarkasaṅgraha of Annambhaṭṭa Motilal Banarsidass, Delhi, 1971
17. Bhattacharya Gopinath (Tr.), Tarkasaṅgraha of Annambhaṭṭa, Progressive Publishers, Calcutta, 1976
18. Bhattacharya I.C., The Elements of Indian Logic and Epistemology (A portion of Tarkasaṅgraha and Dīpikā), Modern Book Agency, Calcutta, 1962
19. Chandra R., Tarkasaṅgraha men sabdarthapariksha Naiyayika Drishti (H), DT, 27-III-IV: 1-12, 1981
20. Chandrasekhara Sastrigal. S, (ed.), Tarkasaṅgraha with Nyāyabodhinī, Vākyavṛtti, Nirukti, Paṭṭābhirāmaṭippaṇī, Tarkasaṅgrahadīpikā, Nīlakanṭhaprakāśikā, Rāmarudrīya, Nṛsimhaprakāśikā, and Paṭṭābhirāmaprakāśikā, Bālamamorama Press, Madras, 1915
21. Chingle S.M., Review of Bhattacharya C, Elements of Indian logic and Epistemology: A portion of Annam-

- bhaṭṭa's Tarkasaṅgraha and Dīpikā, PQA, 36.11: 130-35, 1963
22. Dadhich, Sivadatta Badrinath, Tarkasaṅgraha of Annambhaṭṭa, Laxmi Venkateshwar, Bombay, 1949
  23. Dalvi D.G., Tarkasaṅgraha with Dīpikā and Dīpikā-prakāśikā, Girgauum, Bombay, 1907
  24. Foucher A, (Ed.), Annambhaṭṭa Le Compendium des topiques (Tarkasaṅgraha), Ardrien Maissonneuve, Paris, 1949
  25. Gajendragadkar A.B. & Karmarkar R.D, (Ed.&Tr.), Tarkasaṅgraha of Annambhaṭṭa, Aryabhushan Press, Poona, 1930
  26. Gaud J.P., Tarkasaṅgraha of Annambhaṭṭa with the commentary Krishna with Tippanī, Motilal Banarsidass, Varanasi, 1958
  27. Gopinath Bhattacharya, (Tr.), Tarkasaṅgraha-dīpikā on Tarkasaṅgraha of Annambhaṭṭa, Progressive Publishers, Calcutta, 1976
  28. Hultsch E., (Tr.), Tarkasaṅgraha of Annambhaṭṭa, A short treatise on language and atomic theory with author's own commentary genannt Dīpikā, Weidmannsche Buchhndlung, Berlin, 1907
  29. Jetali J., (Ed.), Tarkasaṅgraha of Annambhaṭṭa with the commentary Phakkika and Dīpikā by Ksamakalyanagani, Rajasthan Oriental Research Institute, Rajasthan Purātana Granthamālā No.9, Jaipur, 1956
  30. Jha M., (Ed.), Bhaskarodaya of Lakshminarasingha Shastri, a commentary of Tarkasaṅgraha-dīpikāprakāśa, Nirṇaya Sāgar Press, Bombay, 1903

31. Jha M., (Ed.), Bhaskarodaya, A commentary on Tarkasaṅgraha-dīpikā-prakāśa, Nirṇaya Sāgar Press, Bombay, 1933 - 5th Edition.
32. Jha Ramachandra, Tarkasaṅgraha of Annambhaṭṭa with the commentaries Nyāyabodhinī of Govardhana and Indumati by the commentator, Harikrishna Nibandha Bhavan, Harikrishna Nibandha Manimala-8, Misc. Nyāya-12, 1960
33. Jha Ramachandra, Tarkasaṅgraha of Annambhaṭṭa with Lakṣaṇa-tippaṇi and Hindi commentary Indumati, Chowkhamba Sanskrit Series Office, Haridasa Sanskrit Series-209, Benaras, 1961
34. Jivaramshastri, Tarkasaṅgraha of Annambhaṭṭa, Siddhāntacandrodayā (comm.), Jyestharam Mukundoji, Nirṇaya Sāgar Press, Bombay, 1900
35. Jog D.V. (Tr.), Tarkasaṅgraha of Annambhaṭṭa with text and Marathi translation, Kantinental Book Service, Pune, 1960
36. Lokesacaitanya B., Tarkasaṅgraha with Dīpikā of Annambhaṭṭa, VK, 55, 389-92, 1969
37. Mehendele K.C., (Ed.), Tarkasaṅgraha of Annambhaṭṭa with Dīpikā, Bombay, 1893
38. Mehendele K.C., (Ed.), Tarkasaṅgraha of Annambhaṭṭa with Dīpikā, Bharata Bharati, Varanasi, 1980
39. Narasinghadeva Shastri Saraswati (Comm.), Tarkasaṅgraha of Annambhaṭṭa with the commentary Bālabodhini, Meharchandra Laksmanadas.
40. Parab Kashinath Pandurangi (Ed.) Tarkasaṅgraha of Annambhaṭṭa with the commentary Dīpikā, Nirṇaya Sāgar Press, Pune, 1888

41. Parab Kashinath Pandurangi (Ed.&Tr.) The Tarkasaṅgraha of Annambhaṭṭa with his own gloss the Dīpikā An English Translation, Pious Book Corporation, Varanasi, 1982 Reprint
42. Paranjape, S.M. (Tr.) Tarkasaṅgraha va Dīpikā of Annambhaṭṭa (M), R.L.Soman, Poona, 1894
43. Pusalkar A.D., Tarkasaṅgraha of Annambhaṭṭa with Dīpikā & *Nyāyabodhinī*, Bhandarkar Oriental Research
44. Raikva Jivarama Lallurama (Ed.), Tarkasaṅgraha of Annambhaṭṭa with the commentary Siddhānta-candrodaya of Krishnadhurjati Dikshita, Jyestharam Mukundaji, Bombay, 1957
45. Randle H.N., A Primer of Indian Logic, According to Annambhaṭṭa's Tarkasaṅgraha, JRAS, 85, 448-49, 1932, 1933
46. S. Kuppuswami Sastri, A Primer of Indian logic on Annambhaṭṭa's Tarkasaṅgraha, Kuppuswami Sastri Research Institute, Madras, 1951
47. Sastrigal C.S., Tarkasaṅgraha of Annambhaṭṭa with Nyāyabodhinī and Vākyavṛtti, Bālamānorama, Madras, 1915
48. Sharma M, (Ed.), Tarkasaṅgrahacandrikā with Tarkasaṅgrahavyākhyā of Annambhaṭṭa, Nirṇaya Sagar Press, Bombay, 1912
49. Sharma M., (Mahādeva) (Ed.), Tarkasaṅgraha of Annambhaṭṭa with Nyāyabodhinī and Padakṛtya, Nirṇaya Sagar Press, Bombay, 1925
50. Sharma-regmi S., (Ed. & Comm.) Tarkasaṅgraha with Padakṛtya, Chowkhamba Surabharati Granthamala No-5 No.1696, Varanasi, 1977



51. Sharma V.V., (Ed.) Tarkasaṅgraha of Annambhaṭṭa with Dīpikā, V.V. & Bros, Trivandrum, 1122
52. Shastri Jivarama (Ed.) Tarkasaṅgraha with the commentary Siddhāntacandrodaya of Srikrishnadhurjati Dikshita, Nirnaya Sagar Press, Bombay, 1900
53. Shastri L. (Comm.) Bhāskarodaya: A commentary on Tarkasaṅgraha-dīpikā-prakāśa edited by Mukund Jha, Nirnaya Sagar Press, Bombay, 1933 (5<sup>th</sup> Edition).
54. Shastri M.V., Tarkasaṅgraha with the commentary Laghubodhinī by Govardhana Rangacarya Kalyana, Lakshmi Venkateswara Press, 1893
55. Shastri Nṛsimhadeva (Ed.), Tarkasaṅgraha of Annambhaṭṭa with Vivṛtti, Saubhāgyavati and Bālabodhinī, Meherchandra Laksamanadass, Lahore, 1926
56. Shastri R.N., Tarkasaṅgraha of Annambhaṭṭa with Tippanī, Chowkhamba Sanskrit Series Office, Benaras, 1961
57. Shastri S.K. (Tr.) Tarkasaṅgraha of Annambhaṭṭa - Primer of Indian Logic, P.Varadachari, Madras, 1932
58. Shastri S.K. (Tr.), Tarkasaṅgraha of Annambhaṭṭa: Primer of Indian Logic, Kuppuswami Shastri Research Institute, Madras, 1951 (2<sup>nd</sup> Edition), 1961 (3<sup>rd</sup> Edition)
59. Shastri S.N., Tarkasaṅgraha of Annambhaṭṭa with the commentaries Bālabodhinī, Upanyāsa and Ullāsa, Bharatiya Publishing House, Delhi, 1974
60. Shastri V.N., Tarkasaṅgraha of Annambhaṭṭa with Hindi commentary, Bharatiya Sanskrit Bhavan, Jalandhar, 1977  
5th Edition

61. Shivadatta (Ed.), Tarkasaṅgraha of Annambhaṭṭa with Nyāyabodhinī and Padakṛtya, Mazgaon Press, Bombay, 1888
62. Shivadatta (Ed.) Tarkasaṅgraha of Annambhaṭṭa with Nyāyabodhinī and Padakṛtya, Venkateshwar Press, Bombay, 1907
63. Shivadatta (Ed.), Tarkasaṅgraha of Annambhaṭṭa with Nīlakaṇṭhī and Dīpikā, Venkateswara Press, Bombay, 1954, 1897
64. Shrirama Shastri K., Tarkasaṅgraha-sarvasva, Kuruganti Srirama Shastri, Tenali, 1924
65. Srīkṛṣṇavallabhācārya (Comm.) Tarkasaṅgraha with the commentaries Dīpikā, Kiraṇāvalī, Nyāyabodhinī and Padakṛtya, Vyasaprakashan, Varanasi
66. Sukthankar B.S., Tarkasaṅgraha of Annambhaṭṭa with Dīpikā, Native Opinion Press, Bombay, 1911
67. Swami Govardhanrangacharya (Ed.), Tarkasaṅgraha with Laghubodhini (comm.), Laxmi Venkateswar Press, Kalyan (Bombay), 1893
68. Tarka-saṅgraha, Annambhaṭṭa, svopajña vyākhyā tarka-dīpikā sahitā, Motilal Banarasidas, 1971
69. Tarkasaṅgraha Sanskrit with Nyāyabodhinī, Vākya-vṛtti, Nirukti and Paṭṭābhirāmaṭippaṇī, Tarkasaṅgraha-dīpikā, Nīlakaṇṭhaprakāśikā, Rāmarudrīya, Nṛsimhaprakāśikā and Paṭṭābhirāma, āśikā. Edited and published by S. Chandrasekhara Sastrigal, New ed. Pub. Sri Bālamānorama series, Madras 4, 1916
70. The Tarkasaṅgraha of Annambhaṭṭa, Pandit Shiva-datta of Jaipur, Kessinger Publishing, LLC, 2010

71. The Tarkasaṅgrahadīpikā and an English Translation, printed and published by the proprietor of the Nirnayasagara press, 1876
72. Tarkasaṅgraha (With Hindi Translation), Pankaj Mishra, Parimal Publications, New Delhi, 2007
73. Tarkasaṅgraha with Dīpikā, Sanskrit Text and Hindi Commentary, Kedar Nath Tripathi, Motilal Banarsidas Pvt. Ltd. (own), 2008
74. Tarkasaṅgraha of Annambhaṭṭa, Satkari Mookerjee, Caukhambā Saṁskṛta Series Office, 1969
75. Tarkasaṅgraha Annambhaṭṭa, Harekānta Miśra, Caukhambā Amarabhāratī Prakāśana, 1985
76. The Tarkasaṅgraha Annambhaṭṭa, James Robert Ballantyne, Presbyterian mission Press, 1851
77. Tarkasaṅgraha, Annambhaṭṭa, Candrajasinha, Candradhara Śukla, Caukhambā Oriyantāliyā, 1976
78. Tripathi Kedarnath, *Tarkasaṅgraha of Annambhaṭṭa* with Nyāyabodhinī, Kalā, Padakṛtya and Hindi Tippana, Virendra Tripathi and Vijay Kumar Tripathi, Varanasi, 1974
79. Veezhinathan N., (Ed.), *Tarkasaṅgrahadīpikā- prakāśikā* with the commentaries Bālapriyā and Prasariṇī, Editor, Madras
80. Vidyasagara Jivanananda (Ed & Tr.) Tarkasaṅgraha of Annambhaṭṭa, Jivananda Vidyasagar, Calcutta, 1872
81. Vidyasagara Jivanananda (Ed & Tr.) *Tarkasaṅgraha of Annambhaṭṭa*, Antiquarians Book Seller, Calcutta, 1887
82. Virapaksanandaswami (Ed.), Tarkasaṅgraha with Dīpikā of Annambhaṭṭa, VK 1971 58.I: 27-33, 58.II : 104-107,

58.III: 136-40, 58.IV : 398-400, 58.X : 432-35, 58-XI :  
459-61, 58.XII : 501-04

83. Viraraghavacharya Uttamur T, (Ed.&Comm.) *Tarka-  
saṅgraha* of Annambhaṭṭa with the commentary  
Sukhapraveśinī, Madras, 1934

ॐ

## Commentaries

Sl. No	Commentary	Commentator
1	तर्कसङ्ग्रहदीपिका/ शिशुहिता	अन्नभट्टः
2	तर्कसंग्रहचन्द्रिका	मुकुन्दझा (शर्मा/भट्टः)
3	कुवलयोल्लासः	कृष्णताताचार्यः
4	चन्द्रोदयः	जीवरामशास्त्री
5	तर्कसंग्रहतत्त्वप्रकाशः	श्रीकण्ठः (?)
6	तर्कसंग्रहटीका	शिवदत्तमिश्रः
7	तर्कसंग्रहदीपिका	सोपज्ञः
8	तर्कसंग्रहव्याख्यानिरुक्तिः	जगन्नाथशास्त्री
9	न्यायचन्द्रिका	-
10	न्यायबोधिनी	गोवर्धनसुधीः (मिश्रः)
11	सुरतकल्पतरुः	श्रीनिवासः
12	तर्कसंग्रहटीका	गदाधरभट्टः
13	तर्कसंग्रहटीका	जगदीशभट्टः
14	पदकृत्यम्	चन्द्रजसिंहः
15	पदकृत्यमञ्जरी	-
16	फक्किका	क्षमाकल्याणगणिः
17	वाक्यवृत्तिः	-
18	वृषकेतुमानसः	हरिहरः/शङ्करः
19	तर्कसंग्रहशङ्कुः	-
20	विरला/ हेत्वाभासोदाहरणम्	दूण्डिराजशास्त्री
21	सुबोधिनी	-
22	प्रभा	अप्पाभट्टः
23	विरला	रामचन्द्रझा
24	पदार्थबोधिका	कर्मचन्द्रयतिः

25	पट्टाभिरामप्रकाशिका/ तर्कसंग्रहदीपिकाप्रकाशिका/ टिप्पणी	पट्टाभिरामशास्त्री
26	बालबोधिनी	रामनारायणतर्कपञ्चाननः
27	बालबोधिनी	नृसिंहदेवः
28	भवन्यासः	—
29	तर्कसंग्रहव्याख्या	मुरारिः
30	वाक्यार्थनिरुक्तिः/ वाक्यार्थबोधिनी	पट्टाभिरामः
31	वाक्यार्थनिरुक्तिव्याख्या	—
32	विवृत्तिः	—
33	तर्कसंग्रहव्याख्या	अनन्तनारायणः
34	सिद्धान्तचन्द्रोदयः/ तर्कसंग्रहविवरणम्	कृष्णधूर्जटीदीक्षितः
35	न्यायबोधिनी/ न्यायार्थलघुबोधिनी/ तर्कप्रकाशिनी	गोवर्धनरंगाचार्यः चण्डेश्वरः/चन्द्रेश्वरः
36	बालबोधिनी	चिदानन्दाश्रमयतिः
37	प्रकाशिका/ नीलकण्ठप्रकाशिका	नीलकण्ठशास्त्रीभट्टः
38	प्रकाशिकाव्याख्या	बलभद्रत्रीपाठी
39	तर्कसंग्रहटीका	मदनभट्ट-उपाध्यायः
40	प्रतिबिम्बः	—
41	विषमस्थलटिप्पणी	गण्डसिंहः
42	तर्कसंग्रहसर्वस्वम्	कुरुगन्तिश्रीरामशास्त्री
43	परिमलः	गुरुप्रसादशास्त्री
44	तर्कसंग्रहव्याख्या	शिवनारायणशास्त्री
45	किरणावली	वामाचरणभट्टाचार्यः
46	कन्दः (गोविन्द)	एस्वज्जपुकार/वैजपुकार
47	विलासिनी	ज्वालाप्रसादगौडः

49	तर्कविलासिनी	मुरलीधरशास्त्री
50	बालप्रिया	एन्.एस्. रामानुज ताताचार्यः
51	तर्कसंग्रहवाक्यार्थनिरुक्तिः	माधवपदाभिरामः
52	तर्कसंग्रहचन्द्रिका	मुकुन्दभट्टगाडगिलः
53	तर्कसंग्रहोपन्यासः/ वाक्यवृत्तिः/ भाष्यवृत्तिः	मेरुशास्त्रीगोडबोले
54	न्यायबोधिनीव्याख्या	शुक्लरत्ननाथः
55	न्यायरत्नप्रकाशिका	रामचन्द्रभट्टाचार्यः
56	निरुक्तिः	रामचन्द्रभट्टाचार्यः
57	मार्त्तण्डः	रामदत्तः
58	तर्कसंग्रहव्याख्या	रामनाथभट्टाचार्यः
59	कौतुकः	रामेश्वरशुक्लः
60	ध्रुवपदा	हरिहरशास्त्री
61	तर्कसंग्रहरङ्गिणी	विन्ध्येश्वरीप्रसादद्विवेदी
62	तर्कसंग्रहव्याख्या	विश्वनाथपञ्चाननः
63	तर्कचन्द्रिका	वैद्यनाथगाडगिलः
64	तर्कसंग्रहव्याख्या	शेषाचार्यः
65	भावदीपिका	श्रीधरः
66	तर्कसंग्रहचन्द्रिका	सुबहुबुद्धिः
67	तर्कसंग्रहवृत्तिः/ न्यायबोधिनी	हरिहरः
68	गुप्तार्थदीपिनी	कृष्णशास्त्री
69	कलिङ्गपरिभाषा	—
70	तर्करत्नमहोदधिः	वेङ्कटाचार्यः
71	प्रकाशः	—
72	तर्कसंग्रहदीपिकाव्याख्या	गदाधरभट्टः
73	विवरणम्	—
74	नृसिंहः/नरसिंहप्रकाशिका	
75	दीपिकाव्याख्याप्रभा	नारायणतीर्थः

76	नीलकण्ठी/ दीपिकाप्रकाशः (शिका)	नीलकण्ठभट्टः
77	प्रकाशिका/रामरुद्री	रामरुद्रभट्टः
78	भास्करोदया	लक्ष्मीनृसिंहः
79	तर्कसंग्रहदीपिकाप्रकाशिका	पट्टाभिरामः
80	तर्कसंग्रहदीपिकाव्याख्या	भण्डारी उपह्व (?) महादेवः
81	टिप्पणी/रामरुद्रीयः	रामरुद्रतर्कवागीशभट्टाचार्यः
82	तर्करत्नव्याख्या	टी. वीरराघवः
83	तत्त्वार्थदीपिका/ तर्कसंग्रहदीपिकाटिप्पणी	वेंकटाचार्यः/वाधुलवेंकटगुरुः
84	तत्त्वार्थदीपिकाव्याख्या	शठकोपः
85	प्रभा/हनुमदीयम्/ हनुमन्ती	हनुमत्पण्डितः
86	प्रसारणा/प्रसारिणी	ताताचार्य स्वामी
87	तर्कसंग्रहव्याख्याबालबोधिनी	दक्षिणामूर्तिसूरिः
88	तर्कसंग्रहव्याख्या	श्रीनिवासार्यसूनुः
89	तर्कसंग्रहप्रकाशिका/ अर्थप्रकाशिका	पुरुषोत्तमः भट्टः
90	तर्कसंग्रहनिरुक्तिव्याख्या	नृसिंहाश्रमी





**Prof. V. N. Jha** (b.1946), is an eminent scholar and proficient in the various branches of Sanskrit learning. His entire life has been devoted to the promotion and propagation of Sanskrit studies through multi-disciplinary approaches, with the sole intention of keeping the language and studies related to it, relevant in the minds of scholars as well as the laity. Towards this he has worked closely and regularly with the language to create new disciplines of study in Sanskrit. He has contributed over 45 books and over 100 articles. Many students have received their Ph.D degree under his tutelage and mentorship.



Prof. Jha is member of a number of national and international academic bodies and institutions, having been honoured by many of them. He was Professor and Director at the Centre for Advanced Study in Sanskrit, University of Pune – a position he has held for 20 years. He was also the founding chairman of the Special Centre for Sanskrit Studies, Jawaharlal Nehru University, New Delhi.

### Our other publications

- Holy Gītā Ready Reference
- Īśvaradarśanam
- Śrīrāmajātakam
- Sulabhasaṃskṛtam
- Gītāñjaliḥ
- Śrīpadmapādacaritam
- Smārtapṛāyaścittam
- Laghukarṇāmṛtam
- Śrīrāmakṛṣṇacaritam
- Sūktisudhā
- Synthesis of Yoga
- Logic of Parāmarśa
- Primal Spirituality Philosophical Knowledge and Plenary Experience
- Dhīmahī – A Research Journal

